



**Trademarks**

**GOODWE** and other GoodWe trademarks are trademarks of GoodWe Company. All other trademarks or registered trademarks mentioned in this manual are owned by GoodWe Technologies Co., Ltd.

**NOTICE**

The information in this user manual is subject to change due to product updates or other reasons. This guide cannot replace the product labels or the safety precautions in the user manual unless otherwise specified. All descriptions in the manual are for guidance only.

# CONTENT

<b>1</b>	<b>About This Manual</b>	<b>1</b>
1.1	Applicable Model	1
1.2	Target Audience	1
1.3	Symbol Definition	1
1.4	Updates	2
<b>2</b>	<b>Safety Precaution</b>	<b>3</b>
2.1	General Safety	3
2.2	PV String Safety	3
2.3	Inverter Safety	4
2.4	Battery	5
2.5	Personnel Requirements	5
2.6	EU Declaration of Conformity	5
<b>3</b>	<b>Product Introduction</b>	<b>6</b>
3.1	Product Overview	6
3.2	Application Scenarios	7
3.3	Working Mode	10
3.3.1	System working mode	10
3.3.2	Inverter operation mode	13
3.4	Functionality	14
3.5	Appearance	16
3.5.1	Parts	16
3.5.2	Dimension	16
3.5.3	Indicator Description	17
3.5.4	Nameplate	18
<b>4</b>	<b>Check and Storage</b>	<b>19</b>
4.1	Check Before Receiving	19
4.2	Deliverables	19
4.3	Storage	20
<b>5</b>	<b>Installation</b>	<b>21</b>
5.1	Installation Requirements	21
5.2	Inverter Installation	24
5.2.1	Moving the Inverter	24
5.2.2	Installing the Inverter	24
<b>6</b>	<b>Electrical Connection</b>	<b>26</b>
6.1	Circuit Diagram	26
6.2	Safety Precaution	28
6.3	Connecting the PE cable	28
6.4	Connecting the AC cable	29

- 6.5 Connecting the DC Input Cable(PV) ..... 32
- 6.6 Connecting the battery cable ..... 34
- 6.7 Communication ..... 35
  - 6.7.1 Connecting the COM cable (Load Control, Remote Shutdown, DI Signal, Generator Control, DRED, RCR and EMS)..... 36
  - 6.7.2 Connecting BMS or Meter COM Cable ..... 38
  - 6.7.3 Installing the COM module ..... 42
- 7 Equipment Commissioning ..... 43**
  - 7.1 Check Before Power ON..... 43
  - 7.2 Power On ..... 43
- 8 System Commissioning ..... 44**
  - 8.1 Indicators and Buttons ..... 44
  - 8.2 Setting Inverter Parameters via SolarGo App ..... 45
  - 8.3 Monitoring via SEMS Portal ..... 45
- 9 Maintenance ..... 46**
  - 9.1 Power Off the Inverter..... 46
  - 9.2 Removing the Inverter ..... 46
  - 9.3 Disposing of the Inverter ..... 46
  - 9.4 Troubleshooting..... 47
  - 9.5 Routine Maintenance..... 56
- 10 Technical Parameters..... 57**
  - 10.1 ES Series Technical Parameters ..... 57
  - 10.2 SBP Series Technical Parameters..... 70

# 1 About This Manual

This manual describes the product information, installation, electrical connection, commissioning, troubleshooting and maintenance. Read through this manual before installing and operating the product. All the installers and users have to be familiar with the product features, functions, and safety precautions. This manual is subject to update without notice. For more product details and latest documents, visit <https://en.goodwe.com>.

## 1.1 Applicable Model

This manual applies to the listed inverters below:

### Hybrid Inverter

- GW3000-ES-20
- GW3500L-ES-BR20
- GW3600-ES-20
- GW3600M-ES-20
- GW3600-ES-BR20
- GW5000-ES-20
- GW5000M-ES-20
- GW6000-ES-20
- GW6000M-ES-20
- GW6000-ES-BR20

### AC-Coupled Inverter

- GW3600-SBP-20
- GW5000-SBP-20
- GW6000-SBP-20

## 1.2 Target Audience

This manual applies to trained and knowledgeable technical professionals only. The technical personnel has to be familiar with the product, local standards, and electric systems.

## 1.3 Symbol Definition

Different levels of warning messages in this manual are defined as follows:



Indicates a high-level hazard that, if not avoided, will result in death or serious injury.



Indicates a medium-level hazard that, if not avoided, could result in death or serious injury.



Indicates a low-level hazard that, if not avoided, could result in minor or moderate injury.

### NOTICE

Highlight and supplement the texts. Or some skills and methods to solve product-related problems to save time.

## **1.4 Updates**

The latest document contains all the updates made in earlier issues.

**V1.0 01.02.2024**

## 2 Safety Precaution

Please strictly follow these safety instructions in the user manual during the operation.

### NOTICE

The inverters are designed and tested strictly complies with related safety rules. Read and follow all the safety instructions and cautions before any operations. Improper operation might cause personal injury or property damage as the inverters are electrical equipment.

### 2.1 General Safety

#### NOTICE

- The information in this user manual is subject to change due to product updates or other reasons. This guide cannot replace the product labels or the safety precautions in the user manual unless otherwise specified. All descriptions in the manual are for guidance only.
- Before installations, read through the user manual to learn about the product and the precautions.
- All installations should be performed by trained and knowledgeable technicians who are familiar with local standards and safety regulations.
- Use insulating tools and wear personal protective equipment when operating the equipment to ensure personal safety. Wear anti-static gloves, cloths, and wrist strips when touching electronic devices to protect the inverter from damage.
- Strictly follow the installation, operation, and configuration instructions in this manual. The manufacturer shall not be liable for equipment damage or personal injury if you do not follow the instructions. For more warranty details, please visit: <https://en.goodwe.com/warranty>.

### 2.2 PV String Safety

#### DANGER

Connect the DC cables of the inverter to the delivered DC terminals. The manufacturer shall not be liable for the equipment damage if other DC terminals are used.









#### WARNING

- Ensure the component frames and the bracket system are securely grounded.
- Ensure the DC cables are connected tightly, securely, and correctly.
- Measure the DC cables with a multimeter to avoid reverse polarity connection. Also, the voltage should be under the permissible range.
- Do not connect one PV string to more than one inverter at the same time. Otherwise, it may cause damage to the inverter.
- The PV modules used with the inverter must have an IEC61730 class A rating.

### 2.3 Inverter Safety

 <b>WARNING</b>	
<ul style="list-style-type: none"> <li>• The voltage and frequency at the connecting point should meet the on-grid requirements.</li> <li>• Additional protective devices like circuit breakers or fuses are recommended on the AC side. Specification of the protective device should be at least 1.25 times the AC rated output current.</li> <li>• Make sure that all the groundings are tightly connected. When there are multiple inverters, make sure that all the grounding points on the enclosures are equipotential bonding.</li> <li>• The alarm can be cleared automatically if the inverter triggers a fault for less than 5 times within 24 hours. The inverter will shutdown for protection after the 5th electric arc fault. The inverter can operate normally after the fault is solved.</li> <li>• BACK-UP function is not recommended if the PV system is not configured with batteries. Otherwise, the risk in system power usage is beyond the equipment manufacturer's warranty scope.</li> </ul>	

 <b>DANGER</b>	
<ul style="list-style-type: none"> <li>• All labels and warning marks should be visible after the installation. Do not cover, scrawl, or damage any label on the equipment.</li> <li>• Warning labels on the inverter are as follows:</li> </ul>	

	High-temperature hazard. Do not touch the product under operation to avoid being burnt.		Delayed discharge. Wait 5 minutes after power off until the components are completely discharged.
	Read through the user manual before any operations.		Potential risks exist. Wear proper PPE before any operations.
	Do not dispose of the inverter as household waste. Discard the product in compliance with local laws and regulations, or send it back to the manufacturer.		Grounding point.
	CE marking		RCM marking
	UKCA marking		



## 2.4 Battery



### WARNING

- The battery used with the inverter shall be approved by the inverter manufacturer. The approved battery list can be obtained through the official website.
- Before installations, read through the corresponding battery's User Manual to learn about the product and the precautions. Strictly follow its requirements.
- If the battery discharged completely, please charge it in strict accordance with the corresponding model's User Manual.
- Factors such as: temperature, humidity, weather conditions, etc. may limit the battery's current and affect its load.
- Contact after-sale service immediately if the battery is not able to be started. Otherwise, the battery might be damaged permanently.
- Use the multimeter to measure the DC cable to avoid reverse polarity connection. Also, the voltage should be under the permissible range.
- Do not connect one battery group to several inverters at the same time. Otherwise, it may cause damage to the inverter.

## 2.5 Personnel Requirements

### NOTICE

- Personnel who install or maintain the equipment must be strictly trained, learn about safety precautions and correct operations.
- Only qualified professionals or trained personnel are allowed to install, operate, maintain, and replace the equipment or parts.

## 2.6 EU Declaration of Conformity

GoodWe Technologies Co., Ltd. hereby declares that the inverter with wireless communication modules sold in the European market meets the requirements of the following directives:

- Radio Equipment Directive 2014/53/EU (RED)
- Restrictions of Hazardous Substances Directive 2011/65/EU and (EU) 2015/863 (RoHS)
- Waste Electrical and Electronic Equipment 2012/19/EU
- Registration, Evaluation, Authorization and Restriction of Chemicals (EC) No 1907/2006 (REACH)

GoodWe Technologies Co., Ltd. hereby declares that the inverter without wireless communication modules sold in the European market meets the requirements of the following directives:

- Electromagnetic compatibility Directive 2014/30/EU (EMC)
- Electrical Apparatus Low Voltage Directive 2014/35/EU (LVD)
- Restrictions of Hazardous Substances Directive 2011/65/EU and (EU) 2015/863 (RoHS)
- Waste Electrical and Electronic Equipment 2012/19/EU
- Registration, Evaluation, Authorization and Restriction of Chemicals (EC) No 1907/2006 (REACH)

You can download the EU Declaration of Conformity on <https://en.goodwe.com>.

### 3 Product Introduction

#### 3.1 Product Overview

##### Intended usage

Inverters control and optimize the power in PV systems through an integrated energy management system. The power generated in the PV system can be used, stored in the battery, output to the Utility Grid, etc.

##### Model

This manual applies to the listed inverters below:

##### Hybrid Inverter

- GW3000-ES-20
- GW3500L-ES-BR20
- GW3600-ES-20
- GW3600M-ES-20
- GW3600-ES-BR20
- GW5000-ES-20
- GW5000M-ES-20
- GW6000-ES-20
- GW6000M-ES-20
- GW6000-ES-BR20

##### AC-Coupled Inverter

- GW3600-SBP-20
- GW5000-SBP-20
- GW6000-SBP-20

##### Model description

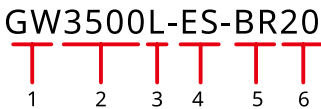

No.	Referring to	Explanation
1	Brand Code	GW: GoodWe
2	Rated Power	6000: the rated power is 6000W.
3	Product Feature	<ul style="list-style-type: none"> <li>• M: the charging and discharging current level of the battery is low.</li> <li>• L: low grid voltage</li> </ul>
4	Series Code	ES: ES Series SBP: SBP Series
5	Country Code	Without note: Universal type BR: Brazil
6	Version Code	20: the version of the inverter is 2.0

### Supported Grid Types

For the grid structure with N cable, the effective value of the voltage between the neutral wire and the ground wire must be less than 10V.

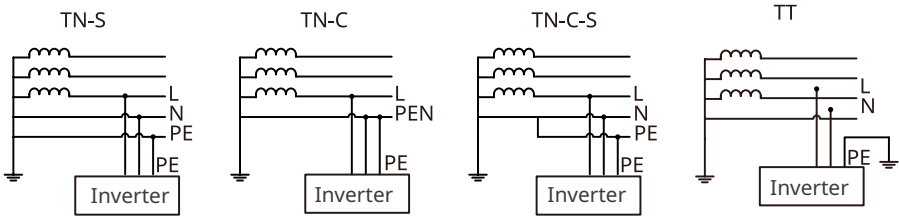

### 3.2 Application Scenarios

#### WARNING

- PV system is not suitable to connect equipment that relies on a stable power supply, such as: medical equipment to sustain life. Ensure that no personal injury is occurred when the system is disconnected.
- BACK-UP function is not recommended if the PV system is not configured with batteries. Otherwise, the risk in system power usage is beyond the equipment manufacturer's warranty scope.
- Factors such as: temperature, humidity, weather, etc. may limit the battery's current and affect its loading capacity.
- When single overload protection occurs, the inverter can restart automatically; however, the restarting time will be extended if it happens several times. For a faster restarting, try it via APP.
- When the grid is disconnected, the off-grid function of the inverter will be closed automatically if the load capacity exceeds the inverter's rated power; to enable it, turn off the large loads and ensure the load power is less than the rated power of the inverter.
- The BACK-UP output port of the inverter has the overload capability and UPS functionality (the switching time is <10 ms). It can provide to the normal household load when the grid is disconnected. To ensure the stability of UPS switching and load power supply, avoid using loads with higher starting current, such as high-power pumps. The supported loads are as follows:
  - For GW3000-ES-20, GW3600-ES-20, GW5000-ES-20, GW6000-ES-20, GW3600-SBP-20, GW5000-SBP-20, GW6000-SBP-20, GW3500L-ES-BR20, GW3600-ES-BR20 and GW6000-ES-BR20: the total power of inductive load and capacitive load is no more than the inverter's rated output power.
  - For GW3600M-ES-20, GW5000M-ES-20 and GW6000M-ES-20: the total power of inductive load and capacitive load is  $\leq 0.5$  times of the inverter's rated output power.

### Self Consumption System (Hybrid Scenarios)

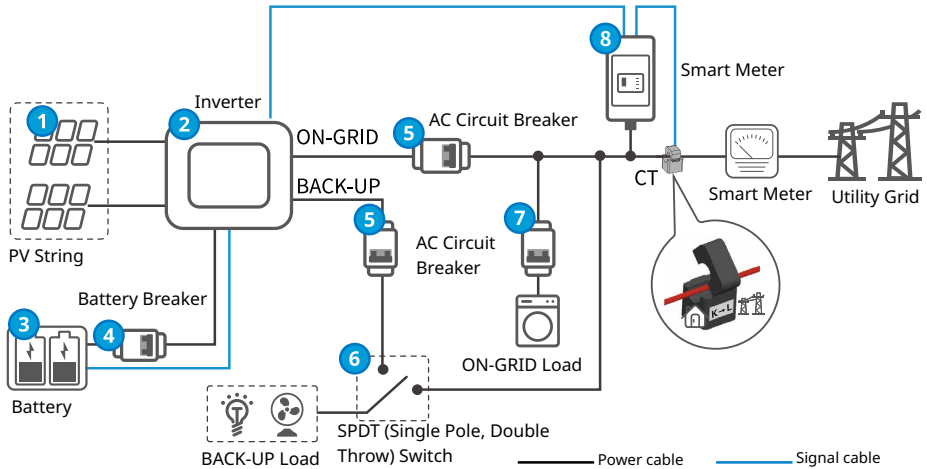

No.	Parts	Description
1	PV String	PV string is composed of series connected PV panels. Only ES series inverters support PV string connection.
2	Inverter	Support ES series inverters.
3	Battery	Select the battery model according to the inverter model and the approved battery list.
4	Battery Breaker	2P AC breakers shall be prepared by the customers with the following specifications: <ul style="list-style-type: none"> <li>For GW3000-ES-20, GW3600M-ES-20, GW5000M-ES-20 and GW6000M-ES-20: the nominal current <math>\geq 75A</math> and the nominal voltage <math>\geq 60V</math>.</li> <li>For GW3600-ES-20, GW3500L-ES-BR20 and GW3600-ES-BR20: the nominal current <math>\geq 100A</math> and the nominal voltage <math>\geq 60V</math>.</li> <li>For GW5000-ES-20: the nominal current <math>\geq 125A</math> and the nominal voltage <math>\geq 60V</math>.</li> <li>For GW6000-ES-20, GW6000-ES-BR20: the nominal current <math>\geq 150A</math> and the nominal voltage <math>\geq 60V</math>.</li> </ul>
5	AC Circuit Breaker	<ul style="list-style-type: none"> <li>The load breaker specifications for the BACK-UP and ON-GRID for one inverter type shall be the same. The AC breakers shall be prepared by the customers.</li> <li>To ensure the BACK-UP load is powered by the grid during the inverter maintenance, install a SPDT (Single Pole, Double Throw) Switch by yourself.</li> <li>The specification of the breaker and SPDT for the BACK-UP and ON-GRID loads:                             <ul style="list-style-type: none"> <li>For GW3600M-ES-20: the nominal current is <math>\geq 20A</math> and the nominal voltage is <math>\geq 230V</math>.</li> <li>For GW3000-ES-20, GW3600-ES-20, GW3600-ES-BR20, GW5000M-ES-20 and GW6000M-ES-20: the nominal current is <math>\geq 40A</math> and the nominal voltage is <math>\geq 230V</math>.</li> <li>For GW3500L-ES-BR20, GW5000-ES-20, GW6000-ES-20 and GW6000-ES-BR20: the nominal current is <math>\geq 63A</math> and the nominal voltage is <math>\geq 230V</math></li> </ul> </li> </ul>
6	SPDT Switch	
7	AC Circuit Breaker	Depend on the actual using load.
8	Smart Meter	The smart meter is delivered with the inverter or purchased from the inverter manufacturer. Recommended model: GM1000 and GM3000

## Self Consumption System (AC-Coupled Scenario)

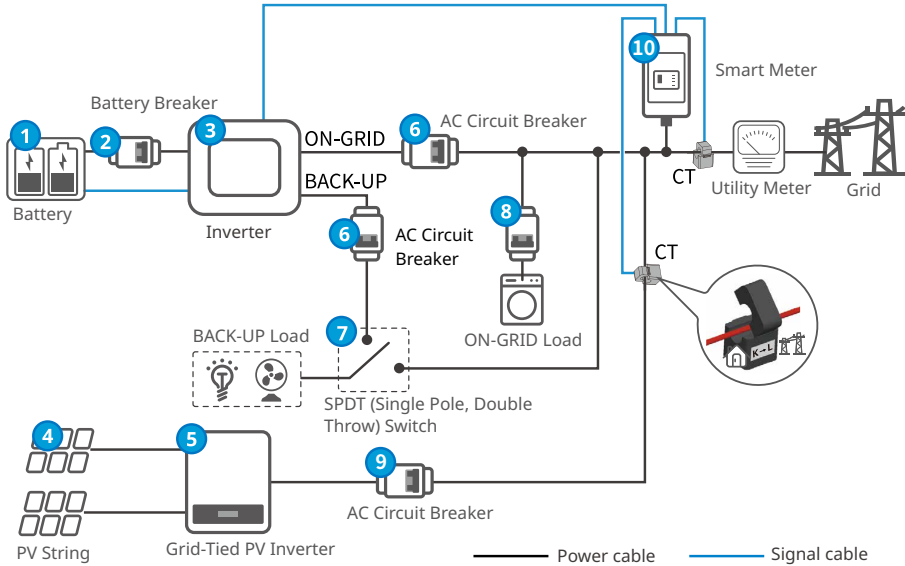

No.	Parts	Description
1	Battery	Select the battery model according to the inverter model and the approved battery list.
2	Battery Breaker	2P AC breakers shall be prepared by the customers with the following specifications: <ul style="list-style-type: none"> <li>For GW3600-SBP-20: the nominal current is <math>\geq 100A</math> and the nominal voltage is <math>\geq 60V</math>.</li> <li>For GW5000-SBP-20: the nominal current is <math>\geq 125A</math> and the nominal voltage is <math>\geq 60V</math>.</li> <li>For GW6000-SBP-20: the nominal current <math>\geq 150A</math> and the nominal voltage <math>\geq 60V</math>.</li> </ul>
3	Inverter	Support SBP series inverters.
4	PV String	PV string is composed of series connected PV panels.
5	Grid-Tied PV Inverter	Support the third Party's PV inverter.
6	AC Circuit Breaker	<ul style="list-style-type: none"> <li>The load breaker specifications for the BACK-UP and ON-GRID for one inverter type shall be the same. The AC breakers shall be prepared by the customers.</li> <li>To ensure the BACK-UP load is powered by the grid during the inverter maintenance, install a SPDT (Single Pole, Double Throw) Switch by yourself.</li> </ul>
7	SPDT Switch	<ul style="list-style-type: none"> <li>The specification of the breaker and SPDT for the BACK-UP and ON-GRID loads: <ul style="list-style-type: none"> <li>For GW3600-SBP-20: the nominal current <math>\geq 40A</math> and the nominal voltage <math>\geq 230V</math>.</li> <li>For GW5000-SBP-20 and GW6000-SBP-20: the nominal current is <math>\geq 63A</math> and the nominal voltage is <math>\geq 230V</math></li> </ul> </li> </ul>
8	AC Circuit Breaker	Depend on the actual using load.
9	AC breaker	AC output switch specifications of The PV grid-connected inverter depend on the PV inverters' AC output rated current.
10	Smart Meter	The smart meter is delivered with the inverter or purchased from the inverter manufacturer. Recommended model: GM1000D

## Parallel Inverter System

### NOTICE

The hybrid inverter supports multiple inverters in parallel. For details, please refer to the Parallel Inverter System Solution User Manual.



Parallel Inverter System  
Solution User Manual

## 3.3 Working Mode

### 3.3.1 System working mode

#### Economic mode

### NOTICE

- Select Economic mode only when it meets the local laws and regulations, e.g., whether the grid is allowed to charge the battery. If not, do not use this mode.
- It is recommended to use economic mode in scenarios when the difference between peak and valley electricity prices is big.

- Day: when the electricity price is in the peak, use the battery to power the load first, and the remaining power can be sold to the grid.
- Night: when the electricity price is in the valley, set the time for the grid to charge the battery.

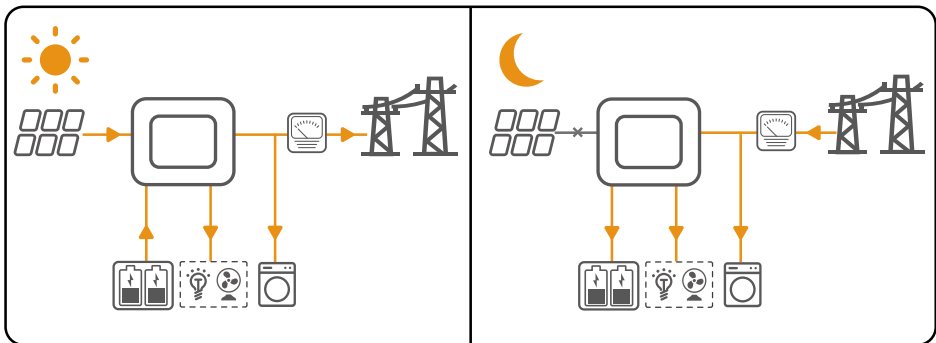

## Self consumption mode

### NOTICE

- For solar power, consider self consumption mode as priority: the excess power charges the battery in day time; the battery supplies power to the load when there is no solar power generated at night. It improves the self consumption rate and saves electricity costs.
- It is suitable for areas with high electricity prices and little or no solar power generation subsidies.

#### • Day:

- When the power generated in the PV system is sufficient, it supplies the household load as priority. And the excess power charges the batteries first. The remaining power will be sold to the grid.
- When the power generated in the PV system is insufficient, use the battery supplies the load first. If the battery power is insufficient, then the load will be powered by the grid.

#### • Night:

If the battery power is sufficient, the load will be powered by the battery. If the battery power is not enough, the load will be powered by the grid.

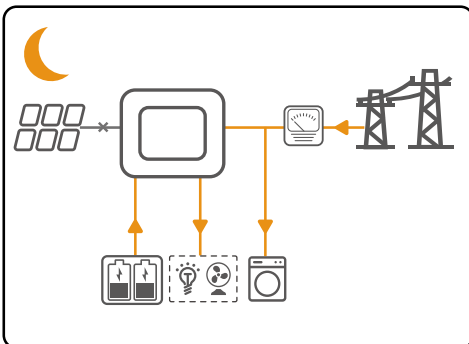
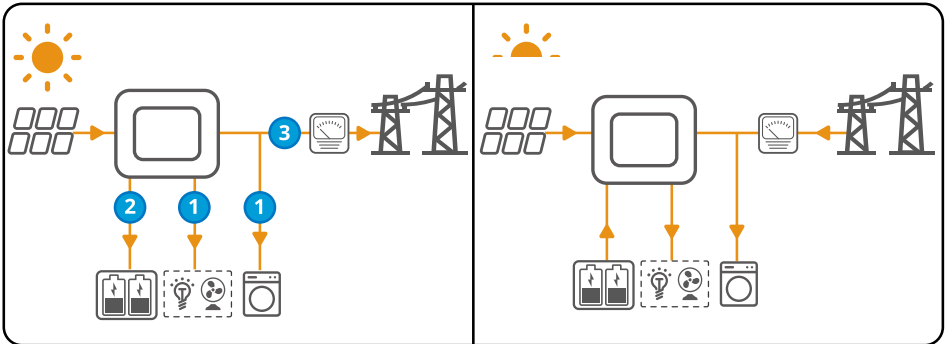

Back-up mode

NOTICE

- The back-up mode is mainly applied to the scenario where the grid is unstable and there is an important load. When the grid is disconnected, the inverter turns to off-grid mode to supply power to the load; when the grid is restored, the inverter switches to on-grid mode.
  - The battery stops discharging when it reaches SOC. When there is sunlight the next day, the battery starts to supply power to the load after it is charged to a certain power level.
- 
- When the power generated in the PV system is sufficient, it charges the battery as priority. And the excess power charges the load. The remaining power will be sold to the grid.
  - When there is no power generated in the PV system:
    - The grid supplies the load when the power grid is normal.
    - The inverter enters off-grid mode and the battery supplies power to the load when the grid is abnormal.

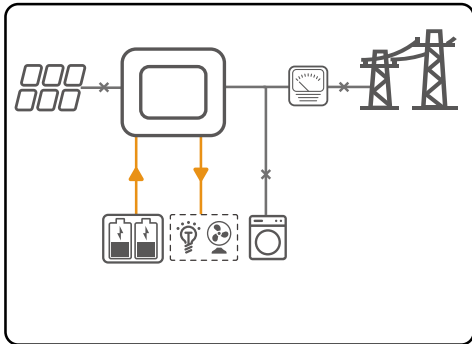
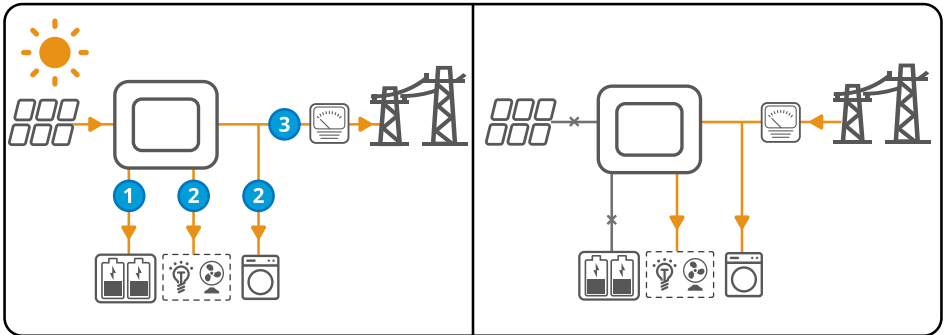



### 3.3.2 Inverter operation mode

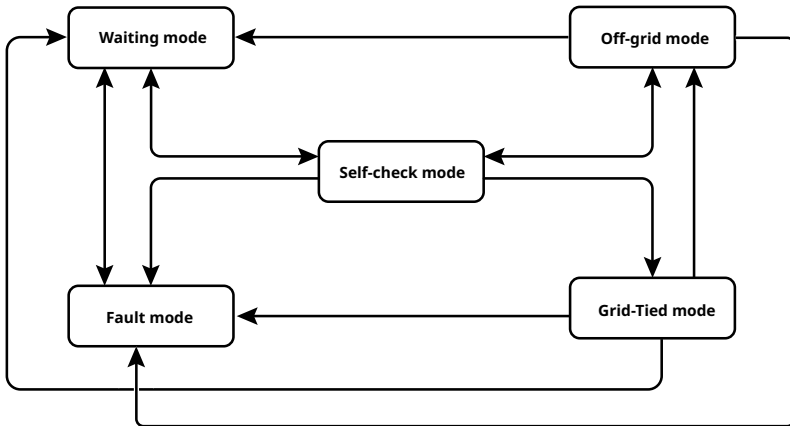

No.	Parts	Description
1	Waiting mode	Waiting stage after the inverter is powered on. <ul style="list-style-type: none"> <li>When the conditions are met, it enters the self-check mode.</li> <li>If there is a fault, the inverter enters the fault mode.</li> </ul>
2	Self-check mode	Before the inverter starts up, it continuously performs self-check, initialization, etc. <ul style="list-style-type: none"> <li>When the conditions are met, it enters the grid-tied mode, and the inverter starts on grid connection.</li> <li>If the grid is not detected, it enters the off-grid mode and the inverter runs off-grid; if the inverter has no off-grid function, it enters the wait mode.</li> <li>If the self-check is not passed, it enters the fault mode.</li> </ul>
3	Grid-Tied mode	The inverter is grid-tied successfully. If the grid is not detected, it enters the off-grid mode. If a fault is detected, it enters the fault mode. If the conditions do not meet grid-tied requirements and the off-grid output function is not turned on, it enters the wait mode.
4	Off-grid mode	When the grid is powered off, the inverter switches to the off-grid mode and continues to supply power to the load via BACK-UP port. If a fault is detected, it enters the fault mode. If the conditions do not meet grid-tied requirements and the off-grid output function is not turned on, it enters the wait mode. If the conditions meet grid-tied requirements and the off-grid output function is turned on, it enters the self-check mode.
5	Fault mode	If a fault is detected, the inverter enters the fault mode. When the fault is cleared, it enters the wait mode.

### 3.4 Functionality

#### Power derating

For a safe operation, the inverter will automatically reduce the output power when the operating environment is not ideal.

The following are the factors that may occur power derating. Please try to avoid them during usage.

- Unfavorable environmental conditions, e.g., direct sunlight, high temperature, etc.
- Inverter's output power percentage has been set.
- Over-frequency derating.
- Higher input voltage value.
- Higher input current value.

#### AFCI

Inverters with AFCI functionality has built-in current sensors to detect the high frequency current signals and decide whether an arc- fault occurs.

Reason to occur electric arcs

- Damaged connectors in PV or battery system.
- Wrong connected or broken cables.
- Aging connectors and cables.

Method to detect electric arcs

- The inverter has an integrated AFCI function.
- When the inverter detects an electric arc, users can find the time of the fault and the detailed phenomenon through the app.
- The alarm can be cleared automatically if the inverter triggers a fault for less than 5 times within 24 hours. The inverter locks for protection after the 5th electric arc fault. The inverter can operate normally after the fault is solved. Please refer to the SolarGo App User Manual for detailed operation.

#### Load Control

The inverter reserves a dry contact controlling port, which supports connecting additional contactors to enable/disable the load.

The load control methods are as follows:

- Time control: set the time to enable/disable the load, and the load will be turned on or off automatically within the setting time period.
- Switch control: when the control mode is selected as ON, the load will be enabled; when it is set as OFF, the load will be disabled.
- BACK-UP load control: the inverter has built-in DO dry contact controlling port, which can control whether the load is off or not by contactor. In off-grid mode, the load connected to the DO port can be turned off if the overload at the BACK-UP end is detected or the battery SOC value is lower than the battery off-grid protection setting.

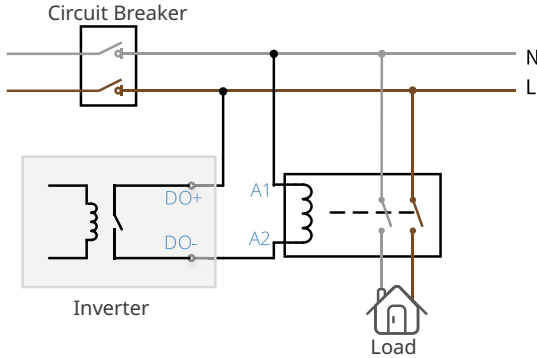

## Communication

The inverter supports setting via WiFi or Bluetooth in a short distance: connected to the Server via WiFi or LAN to monitor the inverter and power plant operations, etc.

- Bluetooth: meets Bluetooth 5.1 standard
- WiFi: supports 2.4G frequency band. Set the router to 2.4G or 2.4G/5G coexistence mode.
  - User can set 40 bytes for router wireless signal name maximumly.
  - It is able to check the WiFi signal intensity via SolarGo App. It is recommended to move the router close to the inverter or clear the signal blocking objects to enhance the signal intensity when it is less than -60.
- LAN (optional): support connecting to the router via LAN communication and then connecting to the Server.
- 4G: support connected to the Server via 4G communication. For 4G module information, please refer to 4G Kit-EC&4G Kit-AU Quick Installation Guide.

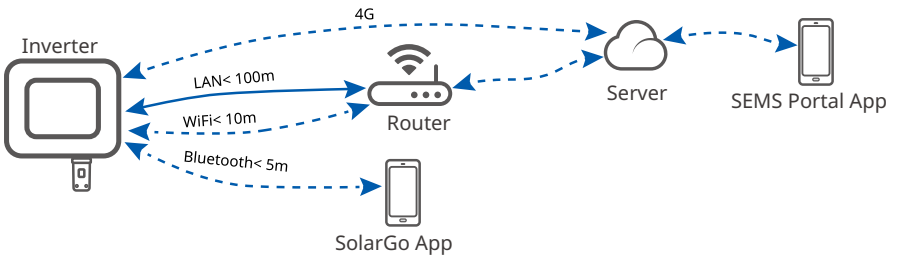

### 3.5 Appearance

#### 3.5.1 Parts

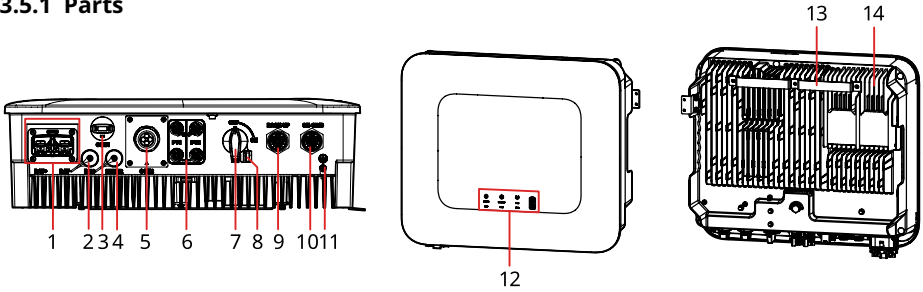

- |    |                                    |    |                           |    |                                      |
|----|------------------------------------|----|---------------------------|----|--------------------------------------|
| 1  | Battery DC Input Port (BATTERY+/-) | 2  | COM Port with BMS (BMS)   | 3  | Communication Module Interface(COM1) |
| 4  | COM Port with Meter (METER)        | 5  | Communication Port (COM2) | 6  | PV DC Input Port (PV1/ PV2)*1        |
| 7  | DC Switch*2                        | 8  | DC Switch Locking Hole*3  | 9  | BACK-UP AC Output Port               |
| 10 | ON-GRID AC Output Port             | 11 | Grounding Terminal        | 12 | LED Indicator                        |
| 13 | Mounting Plate                     | 14 | Heat Sink                 |    |                                      |

\*1: 0 x PV+/PV- for SBP series inverters; 1 x PV+/PV- for GW3000-ES-20 inverters; and 2 x PV+/PV- for other type inverters.







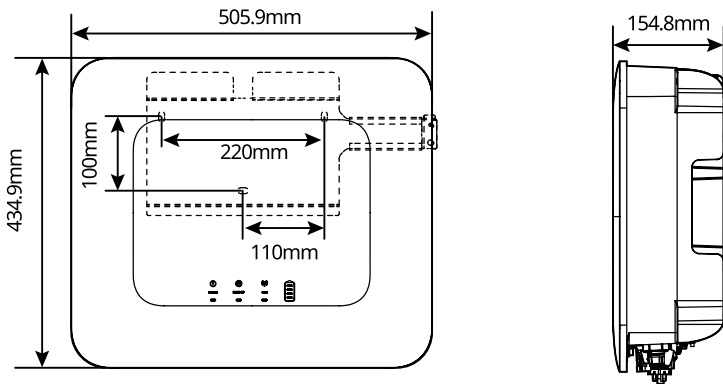









\* 2: only for ES series inverters.

\* 3: only for inverters in Australia.

#### 3.5.2 Dimension



### 3.5.3 Indicator Description

Indicator	Status	Description
		The inverter is power on and in the standby mode.
		The inverter is starting up and in the self-check mode.
		The inverter is in normal operation under grid-tied or off-grid modes.
		BACK-UP output overload
		A fault has occurred.
		The inverter is powered off.
		The grid is abnormal and the inverter is in off-grid mode.
		The grid is normal and the inverter is in grid-tied mode.
		BACK-UP is off.
		The monitoring module of the inverter is resetting.
		The inverter fails to connect with the communication terminal device.
		Faults between the communication terminal device and Server.
		The monitoring of the inverter operates well.
		The monitoring module of the inverter has not been started yet.

### 3.5.4 Nameplate

The nameplate is for reference only.

<b>GOODWE</b>	
<b>Product: Hybrid Inverter</b>	
<b>Model : GW3000-ES-20</b>	
PV Input	UDCmax: 600Vd.c.
	UMPP: 60...550Vd.c.
	IDC,max: 16Ad.c.
	ISC PV: 23Ad.c.
Battery	Ubatt: 40...60Vd.c., Li-Ion
	Ibatt,max (C/D): 60/60Ad.c.
On-grid	UAC,r: 220/230/240Va.c.
	fAC, r: 50/60Hz
	PAC, r: 3kW
	IAC,max (to grid): 13.6Aa.c.
	Sr (to grid): 3kVA
	Smax (to grid): 3kVA
	IAC,max (from grid): 27.3Aa.c.
	Sr (from grid): 3kVA
Back-up	UAC,r: 220/230/240Va.c.
	fAC, r: 50/60Hz
	IAC,max: 13.6Aa.c.
	Sr: 3kVA
Smax: 3kVA	
P.F.: -1,0.8cap...0.8ind, T <sub>Operating</sub> : -25~60°C	
Non-isolated, IP65, protective Class I, OVC DCII/ACIII	
S/N:	
GoodWe Technologies Co., Ltd. E-mail: service@goodwe.com No.90 Zijin Rd., New District, Suzhou, 215011, China	
S/N	

GW trademark, product type, and product model

Technical parameters

Safety symbols and certification marks

Contact information and serial number

## 4 Check and Storage

### 4.1 Check Before Receiving

Check the following items before receiving the product.

1. Check the outer packing box for damage, such as holes, cracks, deformation, and others signs of equipment damage. Do not unpack the package and contact the supplier as soon as possible if any damage is found.
2. Check the inverter model. If the inverter model is not what you requested, do not unpack the product and contact the supplier.
3. Check the deliverables for correct model, complete contents, and intact appearance. Contact the supplier as soon as possible if any damage is found.

### 4.2 Deliverables



#### WARNING

- Connect the DC cables with the delivered terminals. The manufacturer shall not be liable for the damage if other terminals are used.
- N represents the accessories' quantity delivered varies depending on the specific inverter type.
  - DC connector: 0 x PV+/PV- for SBP series inverters; 1 x PV+/PV- for GW3000-ES-20 inverters; and 2 x PV+/PV- for other type inverters.
  - 1 piece of Lead-acid battery thermo sensor cable is delivered if the selected inverter supports lead-acid battery connection.

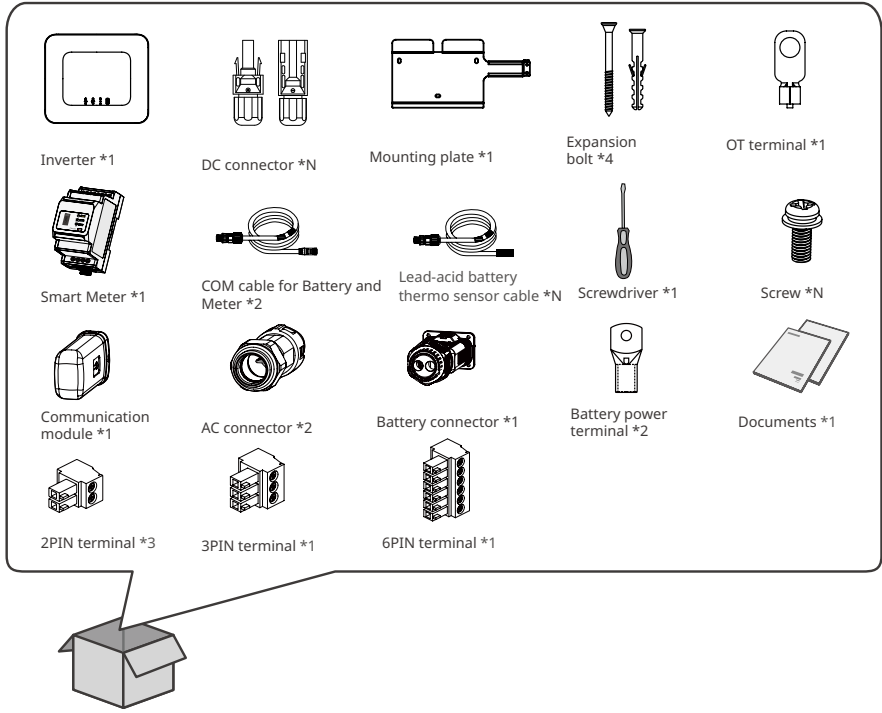

### 4.3 Storage

If the equipment is not to be installed or used immediately, please ensure that the storage environment meets the following requirements:

1. Do not unpack the outer package or throw the desiccant away.
2. Store the equipment in a clean place. Make sure the temperature and humidity are appropriate and no condensation.
3. The height and direction of the stacking inverters should follow the instructions on the packing box.
4. The inverters must be stacked with caution to prevent them from falling.
5. If the inverter has been long term stored, it should be checked by professionals before being put into use.



# 5 Installation

## 5.1 Installation Requirements

### Installation Environment Requirements

1. Do not install the equipment in a place near flammable, explosive, or corrosive materials.
2. Do not install the equipment in a place that is easy to touch, especially within children's reach. High temperature exists when the equipment is working. Do not touch the surface to avoid burning.
3. Avoid the water pipes and cables buried in the wall when drilling holes.
4. Install the equipment in a sheltered place to avoid direct sunlight, rain, and snow. Build a sunshade if it is needed.
5. The place to install the equipment shall be well-ventilated for heat radiation and large enough for operations.
6. The equipment with a high ingress protection rating can be installed indoors or outdoors. The temperature and humidity at the installation site should be within the appropriate range.
7. Install the equipment at a height that is convenient for operation and maintenance, electrical connections, and checking indicators and labels.
8. The altitude to install the inverter shall be lower than the maximum working altitude 3000m.
9. Install the equipment away from electromagnetic interference. If there are radio stations or wireless communication equipment below 30 MHz near the installation location, please install the equipment as follows:
  - Add a multi-turn winding ferrite core at the DC input line or AC output line of the inverter, or add a low-pass EMI filter.
  - The distance between the inverter and the wireless EMI equipment is more than 30m.

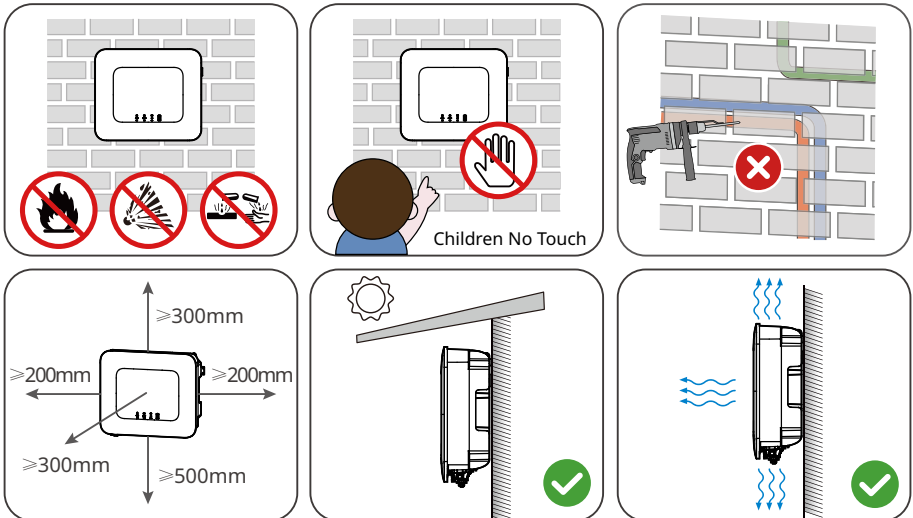

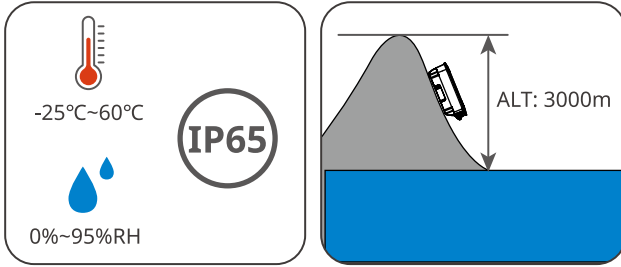

### Mounting Support Requirements

- The mounting support shall be nonflammable and fireproof.
- Install the equipment on a surface that is solid enough to bear the inverter weight.
- Do not install the product on the support with poor sound insulation to avoid the noise generated by the working product, which may annoy the residents nearby.





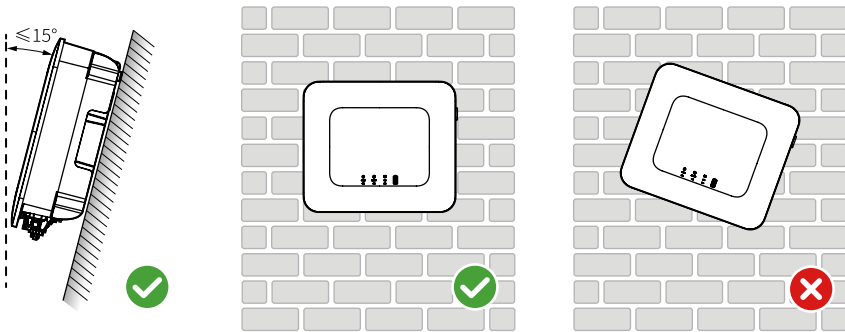





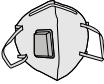
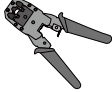

### Installation Angle Requirements

- Install the inverter vertically or at a maximum back tilt of 15 degrees.
- Do not install the inverter upside down, forward tilt, back forward tilt, or horizontally.

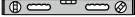

### Installation Tool Requirements

The following tools are recommended when installing the equipment. Use other auxiliary tools on site if necessary.

 Goggles	 Safety shoes	 Safety gloves	 Dust mask	 RJ45 crimping tool
 Diagonal pliers	 Wire stripper	 Hammer drill	 Heat gun	 Vacuum cleaner
 Marker	 Level	 Heat shrink tube	 Rubber hammer	 Torque wrench M3/M5
 Multimeter	 Cable tie			

## 5.2 Inverter Installation

### 5.2.1 Moving the Inverter



#### CAUTION

- Operations such as transportation, turnover, installation and so on must meet the requirements of the laws and regulations of the country or region where it is located.
- Move the inverter to the site before installation. Follow the instructions below to avoid personal injury or equipment damage.
  1. Consider the weight of the equipment before moving it. Assign enough personnel to move the equipment to avoid personal injury.
  2. Wear safety gloves to avoid personal injury.
  3. Keep the equipment in balance during moving to avoid its falling down.

### 5.2.2 Installing the Inverter

#### NOTICE

- Avoid the water pipes and cables buried in the wall when drilling holes.
- Wear goggles and a dust mask to prevent the dust from being inhaled or contacting eyes when drilling holes.
- The DC switch lock of appropriate size should be prepared by customers. Diameter of the lock hole is  $\varnothing 8\text{mm}$  (0.31in). Choose the appropriate size. Otherwise, it might not be able to install. (Supported by hybrid inverter only.)
- The anti-theft lock of appropriate size should be prepared by customers. Diameter of the lock hole is  $\varnothing 10\text{mm}$  (0.39in). Choose the appropriate size. Otherwise, it might not be able to install.
- Make sure the inverter is firmly installed in case of falling down.

**Step 1:** Put the plate on the wall horizontally and mark positions for drilling holes.

**Step 2:** Drill holes to a depth of 80mm (3.15in) by using the hammer drill with diameter of 10mm (0.39in).

**Step 3:** Use the expansion bolts to fix the inverter on the wall.

**Step 4:** (Optional) Secure the DC switch with the DC switch lock, ensuring that the DC switch is "OFF" during installation.

**Step 5:** Install the inverter on the mounting plate.

**Step 6:** Tighten the nuts to secure the mounting plate and the inverter.

**Step 7:** Install the anti-theft lock.

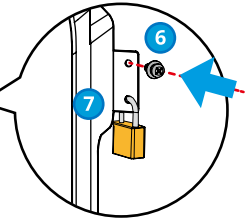
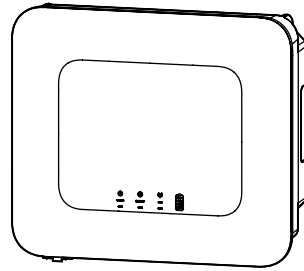
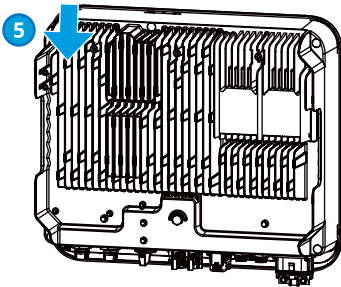
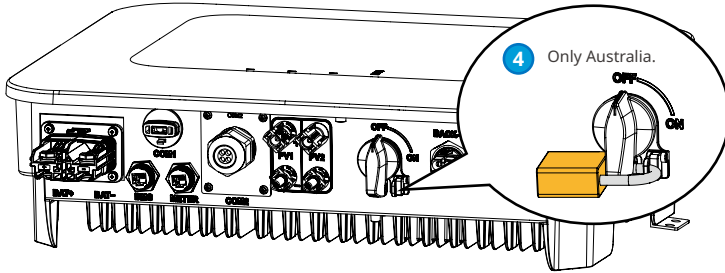
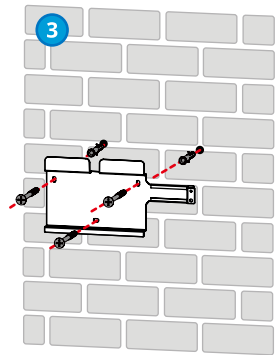
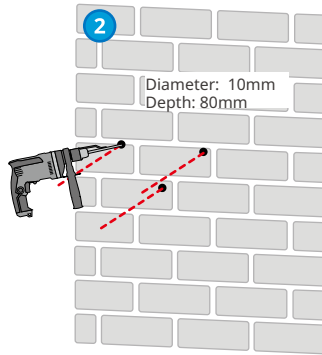
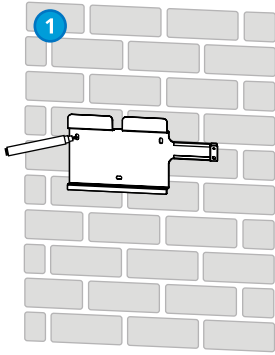

## 6 Electrical Connection

### 6.1 Circuit Diagram

**NOTICE**

- N and PE wiring via ON-GRID and BACK-UP ports of the inverter are different based on the regulation requirements of different regions. Refer to the specific requirements of local regulations.
- There are built-in relays inside of the inverter's ON-GRID and BACK-UP AC ports. When the inverter is in the off-grid mode, the built-in ON-GRID relay is open; while when the inverter is in grid-tied mode, it is closed.
- When the inverter is powered on, the BACK-UP AC port is charged. Power off the inverter first if maintenance is required for the loads connected with BACK-UP ports. Otherwise, it may cause electric shock.
- Only ES series inverters support PV string connection.

**N and PE cables are connected together in the Main Panel for wiring.**

**NOTICE**

Below wirings are applicable to areas in Australia, New Zealand, South Africa, and etc.

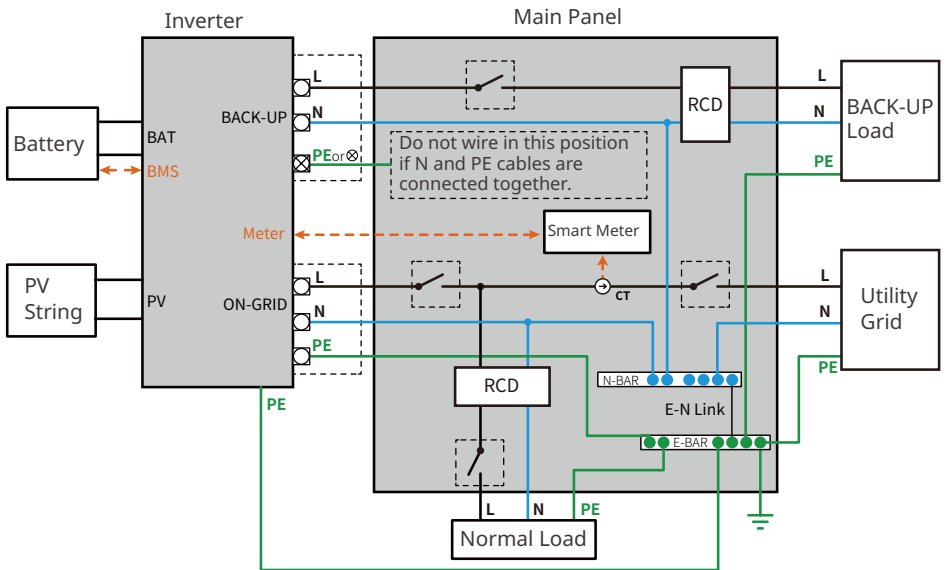

## N and PE cables in the Main Panel shall be wired separately.

### NOTICE

Ensure that the grounding of BACK-UP is correctly and tightened. Otherwise, the BACK-UP function may be abnormal in case of grid failure.

Other areas except Australia, New Zealand, South Africa, etc., are applicable to the following wirings:

- In Germany, the internal relay will connect the N wire and PE cable in back-up mode in 100ms. The internal relay will be disconnected in ON-GRID mode.
- In areas other than Germany, the internal relay is disconnected by default in either mode.

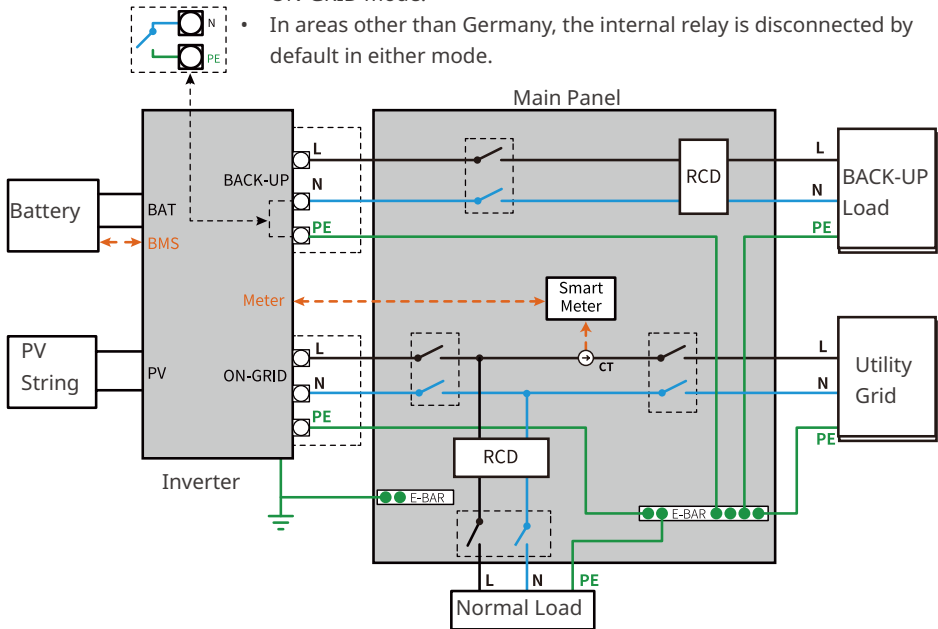

## 6.2 Safety Precaution

 **DANGER**

- All operations, cables and parts specification during the electrical connection shall be in compliance with local laws and regulations.
- Disconnect the DC switch and the AC output switch of the inverter to power off the inverter before any electrical connections. Do not work with power on. Otherwise, an electric shock may occur.
- Tie the same type cables together, and place them separately from cables of different types. Do not place the cables entangled or crossed.
- If the cable bears too much tension, the connection may be poor. Reserve a certain length of the cable before connecting it to the inverter cable port.
- When crimping the terminals, ensure that the conductor part of the cable is in full contact with the terminals. Do not crimp the cable jacket with the terminal. Otherwise the inverter may not operate, or its terminal block getting damaged due to heating and other phenomenon because of unreliable connection after operation.

**NOTICE**

- Wear personal protective equipment like safety shoes, safety gloves, and insulating gloves during electrical connections.
- All electrical connections should be performed by qualified professionals.
- Cable colors in this document are for reference only. The cable specifications shall meet local laws and regulations.

## 6.3 Connecting the PE cable

 **WARNING**

- The PE cable connected to the enclosure of the inverter cannot replace the PE cable connected to the AC output port. Both of the two PE cables must be securely connected
- Make sure that all the grounding points on the enclosures are equipotential connected when there are multiple inverters.
- To improve the corrosion resistance of the terminal, it is recommended to apply silica gel or paint on the ground terminal after installing the PE cable.
- Prepare PE cables with the recommended specification:
  - Type: Outdoor single-core copper wire
  - Cross-sectional area: 4-6mm<sup>2</sup>



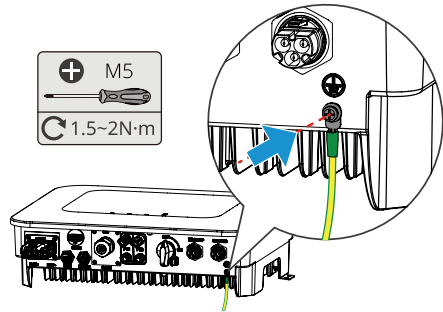
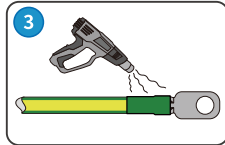
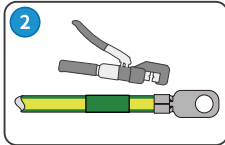
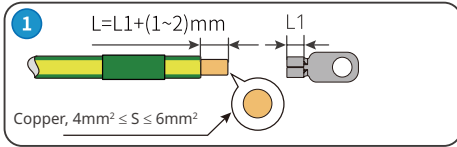

## 6.4 Connecting the AC cable

### WARNING

- Do not connect loads between the inverter and the AC switch directly connected to the inverter.
- The residual current monitoring unit (RCMU) is integrated into the inverter. When the inverter detects the leakage current is bigger than the allowable value, it can disconnect from the grid quickly.
- There are built-in relays inside of the inverter's ON-GRID and BACK-UP AC ports. When the inverter is in the off-grid mode, the built-in ON-GRID relay is open; while when the inverter is in grid-tied mode, it is closed.
- When the inverter is powered on, the BACK-UP AC port is charged. Power off the inverter first if maintenance is required for the loads connected with BACK-UP ports. Otherwise, it may cause electric shock.

Select and Install RCD depending on local laws and regulations. Type A RCDs (Residual Current Monitoring Device) can be connected to the outside of the inverter for protection when the DC component of the leakage current exceeds the limit value. The following RCDs are for reference:

No.	Inverter Model	RCD Type (ON-GRID)	RCD Type (BACK-UP)
1	GW3000-ES-20	300mA	30mA
2	GW3600-ES-20		
3	GW3600M-ES-20		
4	GW5000-ES-20		
5	GW5000M-ES-20		
6	GW6000-ES-20		
7	GW6000M-ES-20		
8	GW3600-SBP-20		
9	GW5000-SBP-20		
10	GW6000-SBP-20		
11	GW3500L-ES-BR20		
12	GW3600-ES-BR20		
13	GW6000-ES-BR20		

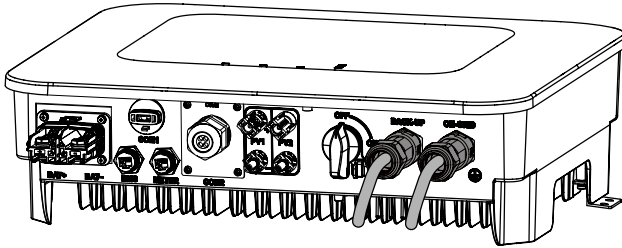

**⚠ WARNING**

- Connect the AC cables to the corresponding terminals such as “L”, “N” and “PE” ports correctly. Otherwise it will cause damage to the inverter.
- Ensure that the whole cable cores are inserted into the terminal holes. No part of the cable core can be exposed.
- Ensure that the cables are connected securely. Otherwise it will cause damage to the inverter due to overheat during its operation.

**Type I**

Supported by GW3600-ES-20, GW5000-ES-20, GW6000-ES-20, GW3600-SBP-20, GW5000-SBP-20, GW6000-SBP-20 GW3500L-ES-BR20, GW3600-ES-BR20, GW6000-ES-BR20 inverters.

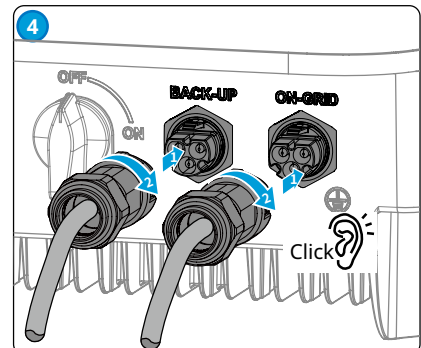
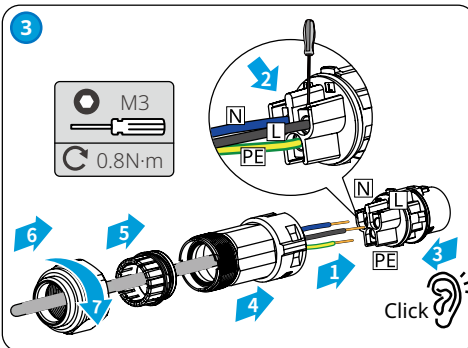
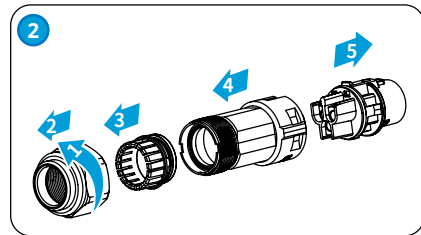
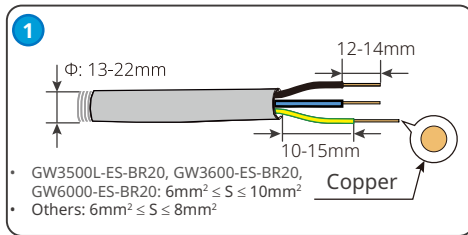

## Type II

Supported by GW3600M-ES-20, GW5000M-ES-20, GW6000M-ES-20, GW6000-SBP-20 inverters.

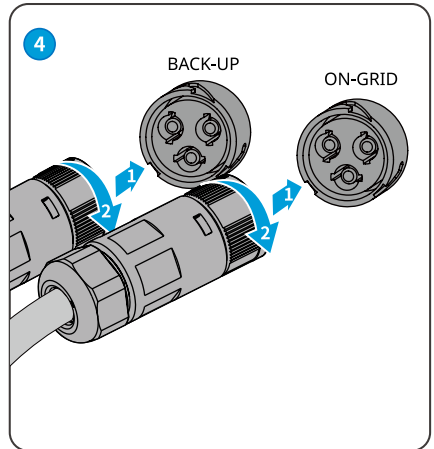
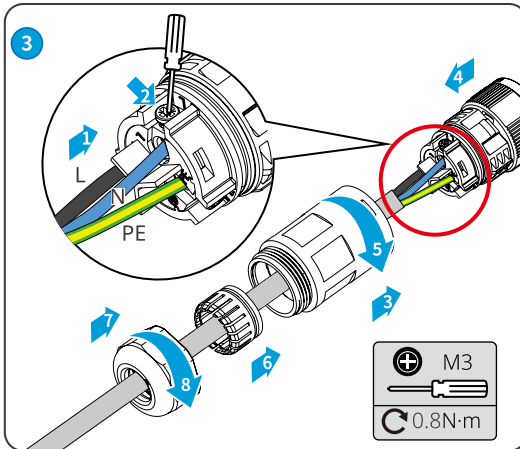
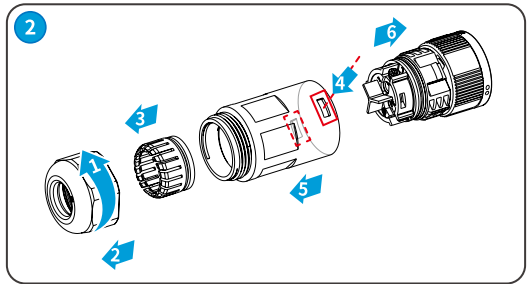
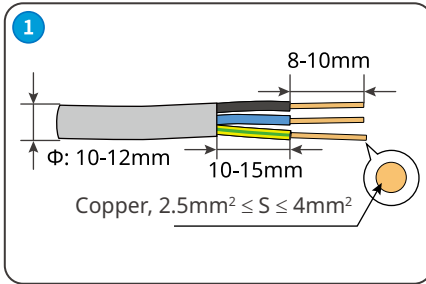

### 6.5 Connecting the DC Input Cable(PV)

**! DANGER**

- Do not connect one PV string to more than one inverter at the same time. Otherwise, it may cause damage to the inverter.
- Confirm the following information before connecting the PV string to the inverter. Otherwise, the inverter may be damaged permanently or even cause fire and cause personal and property losses.
  1. Make sure that the max short circuit current and the max input voltage per MPPT are within the permissible range.
  2. Make sure that the positive pole of the PV string connects to the PV+ of the inverter. And the negative pole of the PV string connects to the PV- of the inverter.

**! WARNING**

The PV strings cannot be grounded. Ensure the minimum insulation resistance of the PV string to the ground meets the minimum insulation resistance requirements before connecting the PV string to the inverter ( $R = \text{maximum input voltage} / 30\text{mA}$ ). If the insulation resistance value is less than above requirement, it will trigger the insulation resistance alarming in the inverter.

Only for ES series inverters.

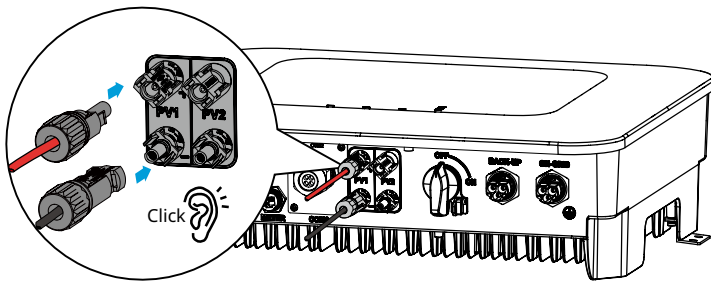

#### MC4

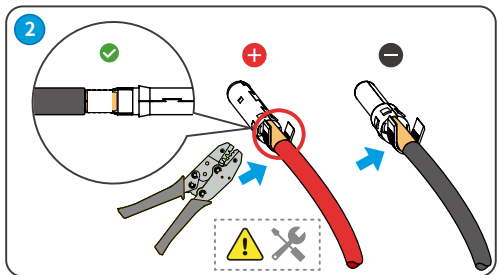
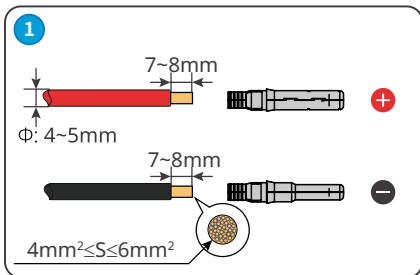

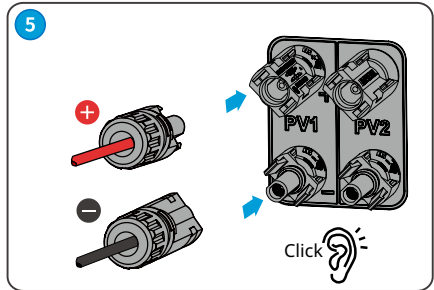
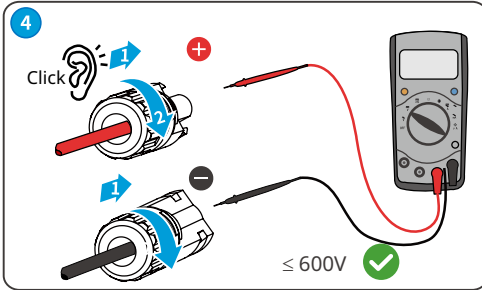
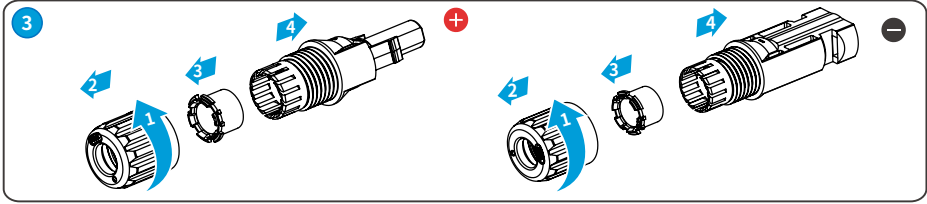

## Vaconn

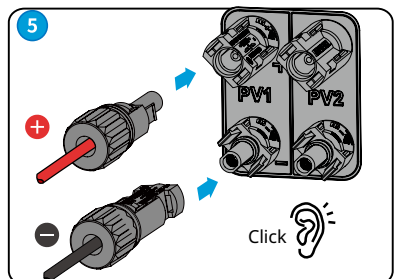
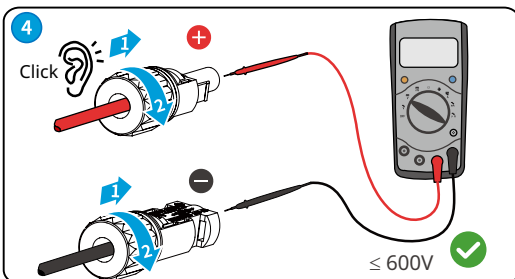
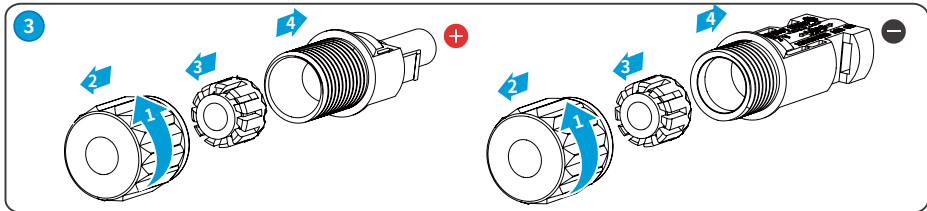
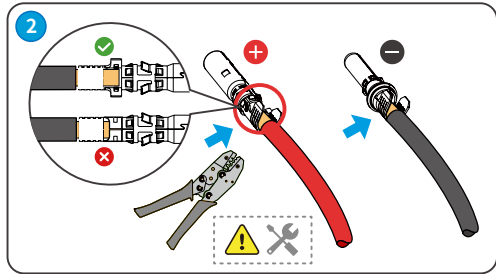
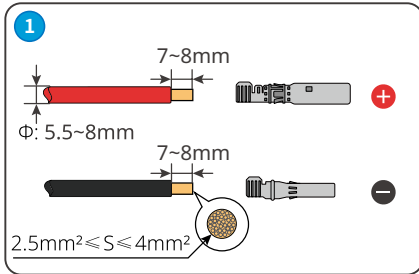

## 6.6 Connecting the battery cable

**! DANGER**

- The battery used with the inverter shall be approved by the inverter manufacturer. The approved battery list can be obtained through the official website.
- A short circuit in the battery may cause personal injury. The instantaneous high current caused by a short circuit can release a large amount of energy and may cause a fire.
- Before connecting the battery cable, ensure the inverter and the battery, and downstream&upstream switches, are all disconnected.
- It is forbidden to connect and disconnect the battery cables when the inverter is running. Otherwise it may cause electric shock.
- Do not connect one battery pack to more than one inverter at the same time. Otherwise, it may cause damage to the inverter.
- It is forbidden to connect loads between the inverter and batteries.
- When connecting battery cables, use insulated tools to prevent accidental electric shock or short circuit to the batteries.
- Ensure that the open circuit voltage of the battery is within the permissible range of the inverter.
- Install a DC switch between the inverter and the battery.

**! WARNING**

- Connect the battery cables to the corresponding terminals such BAT+, BAT- and grounding ports correctly. Otherwise it will cause damage to the inverter. (The battery port of the products sold in Brazil market owns anti-reverse connection function for protection. If the battery port is reversely connected, there is no voltage on the port, thus to prevent devices (such as the inverter and the battery itself) related with the battery wiring not being damaged.
- Ensure that the whole cable cores are inserted into the terminal holes. No part of the cable core can be exposed.
- Ensure that the cables are connected securely. Otherwise it will cause damage to the inverter due to overheat during its operation.

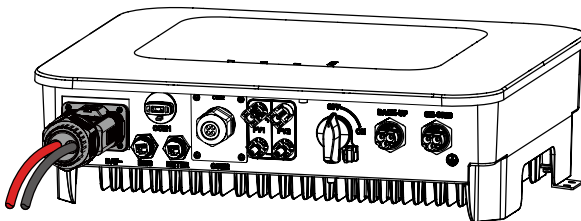

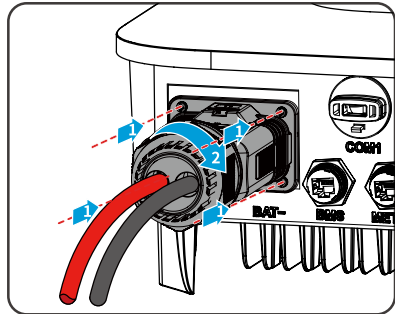
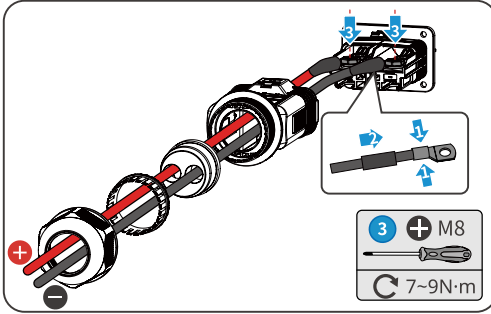
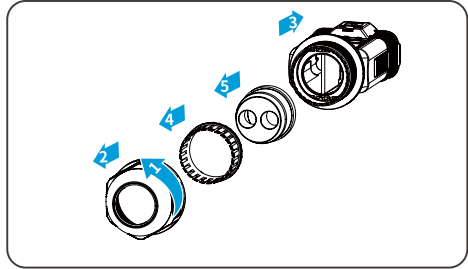
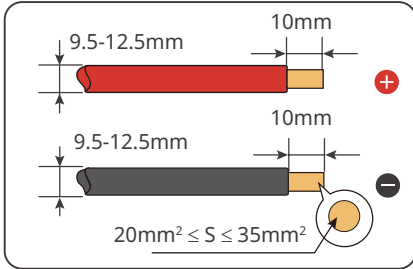

## 6.7 Communication

### NOTICE

Make sure that the communication device is connected to the right COM port. Route the communication cable far away from any interference source or power cable to prevent the signal from being influenced.

**6.7.1 Connecting the COM cable (Load Control, Remote Shutdown, DI Signal, Generator Control, DRED, RCR and EMS)**

No.	Port Definition	Function	Description
1	DO1+	Load Control	The inverter reserves a dry contact controlling port, which supports connecting additional contactors to enable/disable the load.
2	NC		
3	DO1-		
4	Remote Shutdown	Remote Shutdown	Control the inverter to stop when there is accident happening.
5	GND		
6	DI+	Digital Signal Control	The inverter supports accessing commands, alarming or other DI signals remotely via DI ports.
7	DI-		
8	DO2+	Generator start/stop controlling	Support accessing the generator controlling signals.
9	DO2-		
10	COM/DRM0 or REF_1	DRED or Ripple Control Receiver grid dispatching	<ul style="list-style-type: none"> <li>DRED (Demand Response Enabling Device): the inverter satisfies the Australian DERD certification and offers DRED signal controlling ports.</li> <li>RCR Ripple Control Receiver: In Germany and some other European regions, grid companies use Ripple Control Receiver to convert grid dispatching signals into dry contact mode for transferring. And the power station receives grid dispatching signals through dry contact communication mode.</li> </ul>
11	REFGEN or REF_2		
12	DRM 4/8 or DI_4		
13	DRM 3/7 or DI_3		
14	DRM 2/6 or DI_2		
15	DRM 1/5 or DI_1		
16	EMS/PAR	EMS COM or parallelized COM Port	<ul style="list-style-type: none"> <li>EMS COM port: used to connect with the third party device.</li> <li>PAR COM port: serve as the COM port for the inverter parallelizing.</li> </ul>

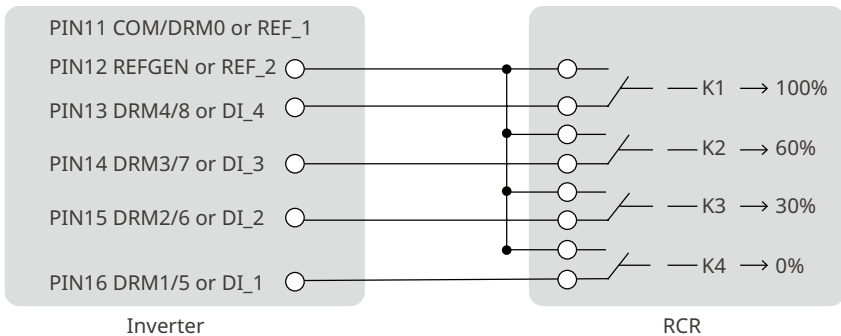



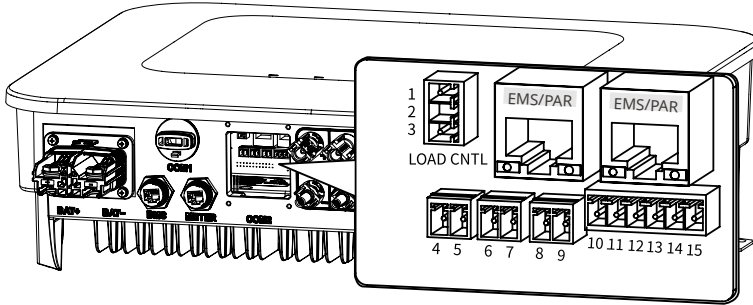

## COM2

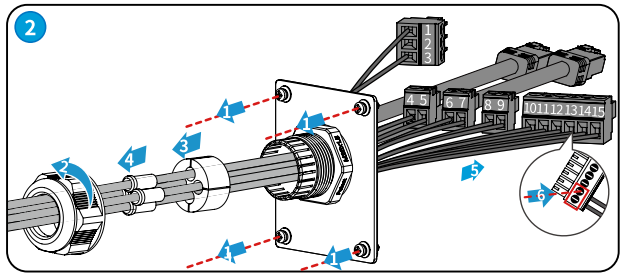
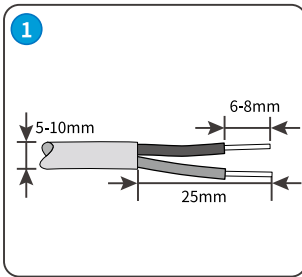

**3**

**Load Control**  
1: DO1+  
2: N/A  
3: DO1-

**DI**  
6: DI+  
7: DI-

**DRED or RCR**  
10: COM/DRM0 or REF\_1  
11: REFGEN or REF\_2  
12: DRM 4/8 or DI\_4  
13: DRM 3/7 or DI\_3  
14: DRM 2/6 or DI\_2  
15: DRM 1/5 or DI\_1

**Remote Shutdown**  
4: Remote Shutdown  
5: GND

**Generator**  
8: DO2+  
9: DO2-

**COM2**

When using the standard Ethernet cable to connect for EMS function, only crimp PIN1 and PIN2 of the RJ45 into 2 wires of them. Do not crimp PIN3-PIN8 into the left wires.

No.	Color	EMS/PAR
1	Orange and White	RS485A (EMS)
2	Orange	RS485B (EMS)
3	Green and White	NC
4	Blue	GND
5	Blue and White	CAN_H(PAR)
6	Green	CAN_H(PAR)
7	Brown and White	BUS1 (PAR)
8	Brown	BUS2(PAR)

### 6.7.2 Connecting BMS or Meter COM Cable

#### Connecting the Lead-acid Battery Thermo Sensor Cable

**NOTICE**

- The inverter is delivered with lead-acid battery thermo sensor cable with 3 meters in length.
- Connect the RJ45 Modular Plug of the sensor cable to the inverter BMS port. Put the metal thermo header on the surface of the lead-acid battery for measurement.

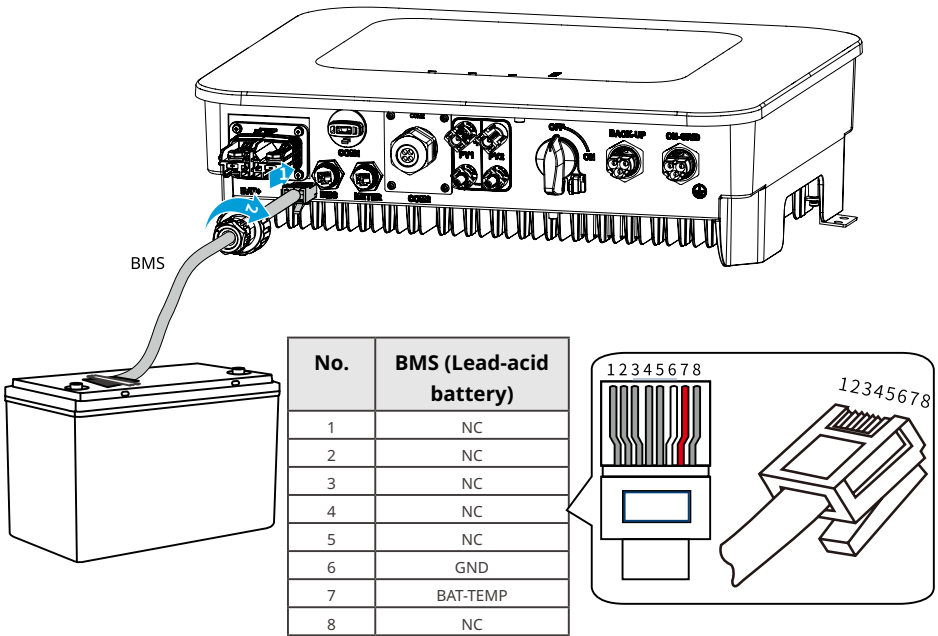

## Connecting the Li-ion Battery BMS Communication and Meter Communication Cables

### NOTICE

- The communication cables between BMS and the battery, and between Meter and the inverter are delivered with the inverter, with default length of 3m and 10m separately. Please install the Meter and CT according to the actual situations.
- The Meter and CT have been preset parameters before delivered with the inverter. Do not modify the relevant parameters.
- Each inverter needs to be connected to one Meter independently. Do not connect multiple inverters to the same Meter.
- Confirm the following items for a proper use of the Meter and CT:
  1. Ensure that CT connects with the corresponding phase line: CT1 is connected to L1; CT2 is connected to L2; and CT3 is connected to L3.
  2. Connect CT according to the pointing direction of the Meter. It will display CT reverse fault on the inverter if it is the opposite direction.
- The BMS and Meter COM ports support connecting with the standard RJ45 crystal head, with the following definition:

No.	Color	BMS (Li-ion Battery)	Smart Meter
1	Orange and White	NC	NC
2	Orange	NC	NC
3	Green and White	NC	NC
4	Blue	CAN_H	NC
5	Blue and White	CAN_L	NC
6	Green	NC	NC
7	Brown and White	NC	485_B1
8	Brown	NC	485_A1

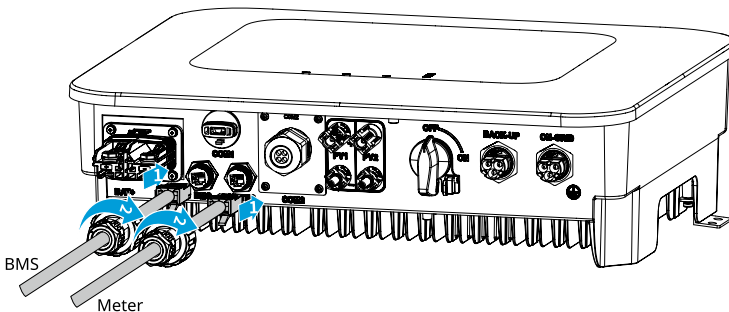
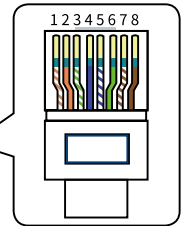

**NOTICE**

Power Limit functionality can be realized when the inverter is installed with the Meter. Testing to AS/NZS 4777.2:2020 for multiple phase combinations has not been conducted. The specific networking schemes are:

**Power Limit networking scheme (Single phase scenario)**

When the load connected is single-phase and no PV inverter is used under the self consumption mode, the Power Limit can be realized by connecting ES and SBP series inverters with GM1000.

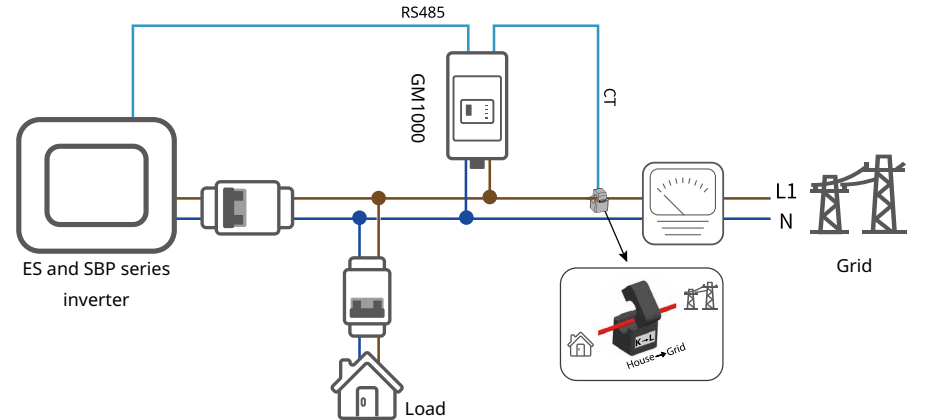

When the load connected is single-phase and SBP series inverters are used under the self consumption mode, the Power Limit can be realized by connecting the inverters with GM1000D. How to realize the anti-reverse function depends on connecting specific inverter with different Meters. There may exist situations when the load gets the electricity from the grid for the Power Limit function. Below networking schemes are for reference only.

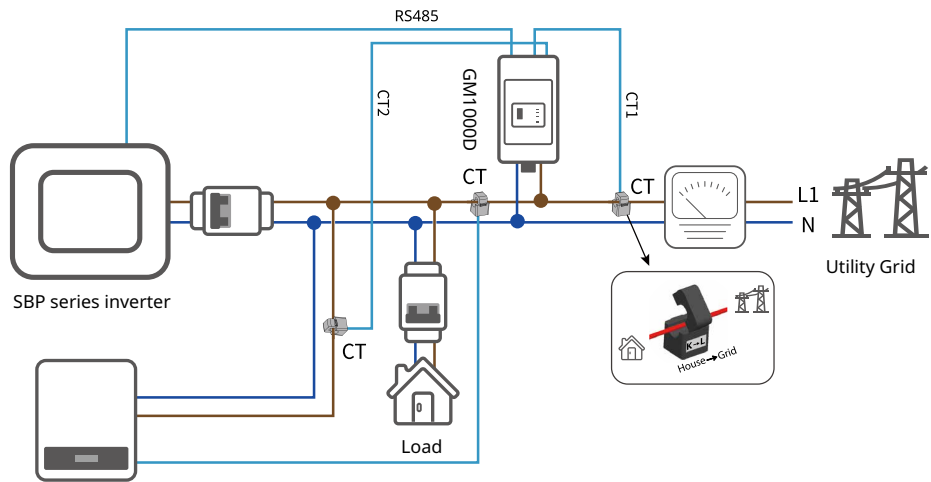

Grid-Tied PV Inverter

## Power Limit networking scheme (Split phase scenario)

When the load connected is split phase, the Power Limit can be realized by connecting ES and SBP series inverters with GM3000. Connect the cables by following below requirements. Otherwise, it may cause Power Limit function failed.

- Power supply port of the Meter: connect the Meter N to Grid N; connect the Meter L1 to Grid L1; connect the Meter L2 to Grid L2; do not connect any cable to the Meter L3 port.
- CT wiring of the Meter: CT1 is connected to L1; CT2 is connected to L2; and do not connect CT3.
- Connect the RS485 port of the Meter to the Meter port of the inverter.
- ON-GRID port of the inverter: connect the L ON-GRID port of the inverter to the Grid L1; and connect the N ON-GRID port of the inverter to the Grid L2.

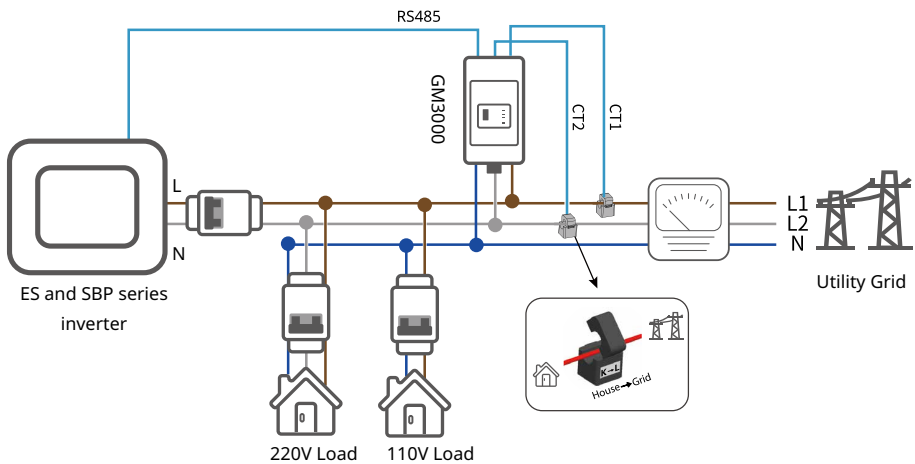

## Power Limit networking scheme (Three phase scenario)

When the load connected is three-phase, the Power Limit can be realized by connecting ES and SBP series inverters with GM3000. Below is the detailed wiring:

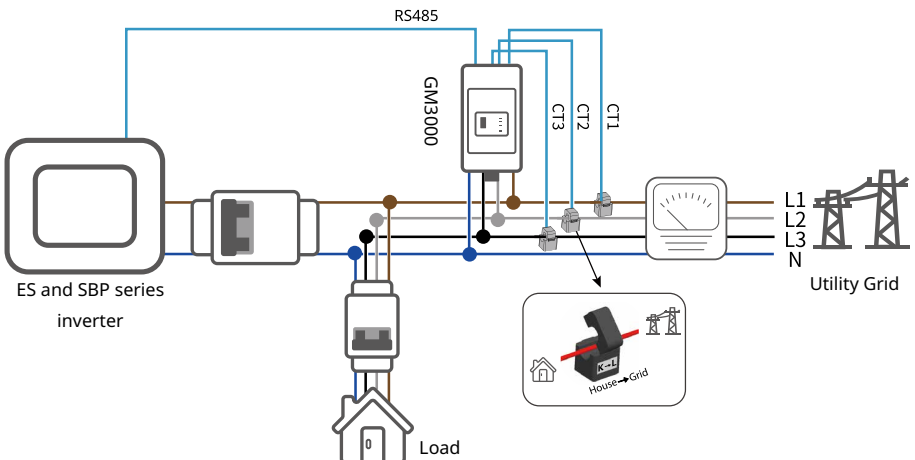

### 6.7.3 Installing the COM module

**NOTICE**

- It supports setting the inverter; connecting to the server for monitoring the inverter and power plant operations etc. via WiFi Kit, Wi-Fi/LAN Kit and 4G module.
- Refer to the delivered communication module user manual to get more introduction to the module. For more detailed information, visit [www.goodwe.com](http://www.goodwe.com).

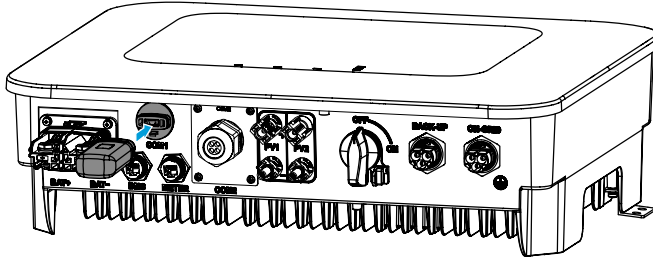

# 7 Equipment Commissioning

## 7.1 Check Before Power ON

No.	Checking Item
1	The product is firmly installed at a clean place that is well-ventilated and easy-to operate.
2	The PE, DC input, AC output, and communication cables are connected correctly and securely.
3	Cable ties are intact, routed properly and evenly.
4	Unused cable holes are fitted using the waterproof nuts.
5	The electrical conduit holes are sealed.
6	The voltage and frequency at the connection point meet the inverter grid connection requirements.

## 7.2 Power On

**Step 1:** Turn on the AC breaker on the ON-GRID side of the inverter.















**Step 2:** Turn on the AC breaker on the BACK-UP side of the inverter.

**Step 3:** Turn on the battery breaker between the inverter and the battery.

**Step 4:** (optional, only for ES series inverters) Turn on the DC switch of the inverter.

## 8 System Commissioning

### 8.1 Indicators and Buttons

Indicator	Status	Description
⏻		The inverter is power on and in the standby mode.
		The inverter is starting up and in the self-check mode.
		The inverter is in normal operation under grid-tied or off-grid modes.
		BACK-UP output overload
		A fault has occurred.
		The inverter is powered off.
⚡		The grid is abnormal and the inverter is in off-grid mode.
		The grid is normal and the inverter is in grid-tied mode.
		BACK-UP is off.
((P))		The monitoring module of the inverter is resetting.
		The inverter fails to connect with the communication terminal device.
		Faults between the communication terminal device and Server.
		The monitoring of the inverter operates well.
		The monitoring module of the inverter has not been started yet.



## 8.2 Setting Inverter Parameters via SolarGo App

### NOTICE

Please set the inverter parameters first via SolarGo App to ensure its normal operation.

SolarGo App is one smart phone application used to communicate with the inverter via bluetooth, WiFi, 4G or GPRS modules. Commonly used functions:

1. Check the operating data, software version, alarms, etc.
2. Set grid parameters, communication parameters, etc.
3. Maintain the equipment.
4. Upgrade the software version of the inverter.

For more details, refer to the SolarGo APP User Manual. Scan the QR code or visit [https://en.goodwe.com/Ftp/EN/Downloads/User%20Manual/GW\\_SolarGo\\_User%20Manual-EN.pdf](https://en.goodwe.com/Ftp/EN/Downloads/User%20Manual/GW_SolarGo_User%20Manual-EN.pdf) to get the user manual.



SolarGo App



SolarGo App  
User Manual

## 8.3 Monitoring via SEMS Portal

SEMS Portal is an monitoring platform used to communicate with the inverter via WiFi, LAN, 4G or GPRS. Commonly used functions:

1. Manage the organization or User information;
2. Add and monitor the power plant information;
3. Maintain the equipment.

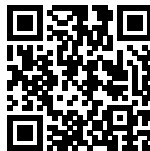

SEMS Portal



SEMS Portal  
User Manual

## 9 Maintenance

### 9.1 Power Off the Inverter



**DANGER**

- Power off the inverter before operations and maintenance. Otherwise, the inverter may be damaged or electric shocks may occur.
- Delayed discharge. Wait until the components are discharged after power off.

**Step 1:** Turn off the AC breaker on the ON-GRID side of the inverter.

**Step 2:** Turn off the AC breaker on the BACK-UP side of the inverter.

**Step 3:** Turn off the battery breaker between the inverter and the battery.

**Step 4:** (optional, only for ES series inverters) Turn off the DC switch of the inverter.

### 9.2 Removing the Inverter



**WARNING**

- Make sure that the inverter is powered off.
- Wear proper PPE before any operations.

**Step 1:** Disconnect all the cables, including DC cables, AC cables, communication cables, the communication module, and PE cables.

**Step 2:** Remove the inverter from the mounting plate.

**Step 3:** Remove the mounting plate.

**Step 4:** Store the inverter properly. If the inverter needs to be used later, ensure that the storage conditions meet the requirements.

### 9.3 Disposing of the Inverter

If the inverter cannot work anymore, dispose of it according to the local disposal requirements for electrical equipment waste. The inverter cannot be disposed of together with household waste.

## 9.4 Troubleshooting

Perform troubleshooting according to the following methods. Contact the after-sales service if these methods do not work.

Collect the information below before contacting the after-sales service, so that the problems can be solved quickly.

- Inverter information like serial number, software version, installation date, fault time, fault frequency, etc.
- Installation environment, including weather conditions, whether the PV modules are sheltered or shadowed, etc. It is recommended to provide some photos and videos to assist in analyzing the problem.
- Utility grid situation.

No.	Fault	Cause	Solutions
1	Utility Loss	1. Utility grid power fails. 2. The AC cable is disconnected, or the AC breaker is off.	1. The alarm is automatically cleared after the grid power supply is restored. 2. Check whether the AC cable is connected and the AC breaker is on.
2	Grid Overvoltage	The grid voltage exceeds the permissible range, or the duration of high voltage exceeds the requirement of HVRT.	1. If the problem occurs occasionally, the utility grid may be abnormal temporarily. The inverter will recover automatically after detecting that the utility grid is normal. 2. If the problem occurs frequently, check whether the grid voltage is within the permissible range. <ul style="list-style-type: none"> <li>• Contact the local power company if the grid voltage exceeds the permissible range.</li> <li>• Modify the overvoltage protection threshold, HVRT or disable the overvoltage protection function after obtaining the consent of the local power company if the grid frequency is within the permissible range.</li> </ul> 3. Check whether the AC breaker and the output cables are connected securely and correctly if the problem persists.

No.	Fault	Cause	Solutions
3	Grid Rapid Overvoltage	The grid voltage is abnormal or ultra-high.	<ol style="list-style-type: none"> <li>1. If the problem occurs occasionally, the utility grid may be abnormal temporarily. The inverter will recover automatically after detecting that the utility grid is normal.</li> <li>2. If the problem occurs frequently, check whether the grid voltage is within the permissible range.                             <ul style="list-style-type: none"> <li>• Contact the local power company if the grid voltage exceeds the permissible range.</li> <li>• Modify the grid overvoltage rapid protection threshold after obtaining the consent of the local power company if the grid voltage is within the permissible range.</li> </ul> </li> </ol>
4	Grid Undervoltage	The grid voltage is lower than the permissible range, or the duration of low voltage exceeds the requirement of LVRT.	<ol style="list-style-type: none"> <li>1. If the problem occurs occasionally, the utility grid may be abnormal temporarily. The inverter will recover automatically after detecting that the utility grid is normal.</li> <li>2. If the problem occurs frequently, check whether the grid voltage is within the permissible range.                             <ul style="list-style-type: none"> <li>• Contact the local power company if the grid voltage exceeds the permissible range.</li> <li>• Modify the undervoltage protection threshold, LVRT or disable the undervoltage protection function after obtaining the consent of the local power company if the grid frequency is within the permissible range.</li> </ul> </li> <li>3. Check whether the AC breaker and the output cables are connected securely and correctly if the problem persists.</li> </ol>

No.	Fault	Cause	Solutions
5	Grid 10min Overvoltage	The moving average of grid voltage in 10min exceeds the range of safety requirements.	<ol style="list-style-type: none"> <li>1. If the problem occurs occasionally, the utility grid may be abnormal temporarily. The inverter will recover automatically after detecting that the utility grid is normal.</li> <li>2. If the problem occurs frequently, check whether the grid voltage is within the permissible range. <ul style="list-style-type: none"> <li>• Contact the local power company if the grid voltage exceeds the permissible range.</li> <li>• Modify the grid overvoltage rapid protection threshold after obtaining the consent of the local power company if the grid voltage is within the permissible range.</li> </ul> </li> </ol>
6	Grid Overfrequency	Utility grid exception. The actual grid frequency exceeds the requirement of the local grid standard.	<ol style="list-style-type: none"> <li>1. If the problem occurs occasionally, the utility grid may be abnormal temporarily. The inverter will recover automatically after detecting that the utility grid is normal.</li> <li>2. If the problem occurs frequently, check whether the grid frequency is within the permissible range. <ul style="list-style-type: none"> <li>• Contact the local power company if the grid frequency exceeds the permissible range.</li> <li>• Modify the overfrequency protection threshold or disable the overfrequency protection function after obtaining the consent of the local power company if the grid frequency is within the permissible range.</li> </ul> </li> </ol>

No.	Fault	Cause	Solutions
7	Grid Underfrequency	Utility grid exception. The actual grid frequency is lower than the requirement of the local grid standard.	<ol style="list-style-type: none"> <li>1. If the problem occurs occasionally, the utility grid may be abnormal temporarily. The inverter will recover automatically after detecting that the utility grid is normal.</li> <li>2. If the problem occurs frequently, check whether the grid frequency is within the permissible range.                             <ul style="list-style-type: none"> <li>• Contact the local power company if the grid frequency exceeds the permissible range.</li> <li>• Modify the underfrequency protection threshold or disable the underfrequency protection function after obtaining the consent of the local power company if the grid frequency is within the permissible range. Or close “Grid Underfrequency” function.</li> </ul> </li> </ol>
8	Grid Frequency Instability	Utility grid exception. The actual grid frequency change rate does not meet the requirement of the local grid standard.	<ol style="list-style-type: none"> <li>1. If the problem occurs occasionally, the utility grid may be abnormal temporarily. The inverter will recover automatically after detecting that the utility grid is normal.</li> <li>2. If the problem occurs frequently, check whether the grid frequency is within the permissible range.                             <ul style="list-style-type: none"> <li>• Contact the local power company if the grid frequency exceeds the permissible range.</li> <li>• Contact the dealer or the after-sales service if the grid frequency is within the permissible range.</li> </ul> </li> </ol>

No.	Fault	Cause	Solutions
9	Anti-islanding	The utility grid is disconnected. The utility grid is disconnected according to the safety regulations, but the grid voltage is maintained due to the loads.	<ol style="list-style-type: none"> <li>1. Check whether the utility grid is disconnected.</li> <li>2. Contact the dealer or the after-sales service.</li> </ol>
10	LVRT Undervoltage	Utility grid exception. The duration of the utility grid exception exceeds the set time of LVRT.	<ol style="list-style-type: none"> <li>1. If the problem occurs occasionally, the utility grid may be abnormal temporarily. The inverter will recover automatically after detecting that the utility grid is normal.</li> <li>2. If the problem occurs frequently, check whether the grid frequency is within the permissible range. If not, contact the local power company. If yes, contact the dealer or the after-sales service.</li> </ol>
11	HVRT Overvoltage	Utility grid exception. The duration of utility grid exception exceeds the set time of HVRT.	<ol style="list-style-type: none"> <li>1. If the problem occurs occasionally, it may be caused by a cable exception. The inverter will recover automatically after the problem is solved.</li> <li>2. Check whether the impedance between the PV string and PE is too low if the problem occurs frequently or persists.</li> </ol>
12	Abnormal GFCI 30mA	The input insulation impedance to the ground decreases when the inverter is working.	<ol style="list-style-type: none"> <li>1. If the problem occurs occasionally, it may be caused by a cable exception. The inverter will recover automatically after the problem is solved.</li> <li>2. Check whether the impedance between the PV string and PE is too low if the problem occurs frequently or persists.</li> </ol>
13	Abnormal GFCI 60mA		
14	Abnormal GFCI 150mA		
15	Abnormal GFCI		

No.	Fault	Cause	Solutions
16	Large DC of AC current L1	The DC component of the output current exceeds the safety range or default range.	<ol style="list-style-type: none"> <li>1. If the problem is caused by an external fault like a utility grid exception or frequency exception, the inverter will recover automatically after solving the problem.</li> <li>2. If the problem occurs frequently and the PV station cannot work properly, contact the dealer or the after-sales service.</li> </ol>
17	Large DC of AC current L2		
18	Low Insulation Res. (Earth Fault Alarm)	<ol style="list-style-type: none"> <li>1. The PV string is short-circuited to PE.</li> <li>2. The PV system is in a moist environment and the cable is not well insulated to the ground.</li> <li>3. The earth resistance is equal to or less than the resistance limit threshold specified.</li> </ol>	<ol style="list-style-type: none"> <li>1. Check whether the resistance of the PV string to PE exceeds 50kΩ. If no, check the short circuit point.</li> <li>2. Check whether the PE cable is connected correctly.</li> <li>3. If the resistance is lower on rainy days, please reset the <b>ISO</b> parameter with SolarGo App.</li> </ol> <p>Inverters for the Australian and New Zealand markets can also be alerted in the following ways in the event of insulation impedance failure:</p> <ol style="list-style-type: none"> <li>1. The inverter is built-in a buzzer: the buzzer sounds continuously for 1 minute in case of failure; If the fault is not resolved, the buzzer sounds every 30 minutes.</li> <li>2. Add the inverter to the monitoring platform, and set the alarm reminder, the alarm information can be sent to the customer by emails.</li> </ol>
19	Abnormal Ground	<ol style="list-style-type: none"> <li>1. The PE cable of the inverter is not connected well.</li> <li>2. The L cable and N cable are connected reversely when output of the PV string is grounded.</li> </ol>	<ol style="list-style-type: none"> <li>1. Check whether the PE cable of the inverter is connected properly.</li> <li>2. Check whether the L cable and N cable are connected reversely if output of the PV string is grounded.</li> </ol>



No.	Fault	Cause	Solutions
20	Anti Reverse current protection for hardwares	Abnormal fluctuation of load	<ol style="list-style-type: none"> <li>1. If the exception is caused by an external fault, the inverter will recover automatically after solving the problem.</li> <li>2. If the problem occurs frequently and the PV station cannot work properly, contact the dealer or the after-sales service.</li> </ol>
21	Internal Comm Loss	<ol style="list-style-type: none"> <li>1. Frame format error</li> <li>2. Parity checking error</li> <li>3. Can bus offline</li> <li>4. Hardware CRC error</li> <li>5. Send (receive) control bit is receive (send).</li> <li>6. Transmit to the unit that is not allowed.</li> </ol>	<p>Disconnect the AC output switch and DC input switch, then connect them 5 minutes later. Contact the dealer or the after-sales service if the problem persists.</p>
22	AC HCT Check abnormal	The sampling of the AC HCT is abnormal.	<p>Disconnect the AC output switch and DC input switch, then connect them 5 minutes later. Contact the dealer or the after-sales service if the problem persists.</p>
23	GFCI HCT Check abnormal	The sampling of the GFCI HCT is abnormal.	<p>Disconnect the AC output switch and DC input switch, then connect them 5 minutes later. Contact the dealer or the after-sales service if the problem persists.</p>
24	Relay Check abnormal	<ol style="list-style-type: none"> <li>1. The relay is abnormal or short-circuited.</li> <li>2. The control circuit is abnormal.</li> <li>3. The AC cable connection is abnormal, like a virtual connection or short circuit.</li> </ol>	<p>Disconnect the AC output switch and DC input switch, then connect them 5 minutes later. Contact the dealer or the after-sales service if the problem persists.</p>

No.	Fault	Cause	Solutions
26	Flash Fault	The internal Flash storage is abnormal.	Disconnect the AC output switch and DC input switch, then connect them 5 minutes later. Contact the dealer or the after-sales service if the problem persists.
27	DC Arc Fault	<ol style="list-style-type: none"> <li>1. The DC terminal is not firmly connected.</li> <li>2. The DC cable is broken.</li> </ol>	Read the Quick Installation Guide and check whether the cables are connected properly.
28	AFCI Self-check Fault	AFCI detection is abnormal.	Disconnect the AC output switch and DC input switch, then connect them 5 minutes later. Contact the dealer or the after-sales service if the problem persists.
29	Cavity Over temperature	<ol style="list-style-type: none"> <li>1. The inverter is installed in a place with poor ventilation.</li> <li>2. The ambient temperature exceeds 60°C.</li> <li>3. A fault occurs in the internal fan of the inverter.</li> </ol>	<ol style="list-style-type: none"> <li>1. Check the ventilation and the ambient temperature at the installation point.</li> <li>2. If the ventilation is poor or the ambient temperature is too high, improve the ventilation and heat dissipation.</li> <li>3. Contact the dealer or after-sales service if both the ventilation and the ambient temperature are normal.</li> </ol>
30	BUS Overvoltage	<ol style="list-style-type: none"> <li>1. The PV voltage is too high.</li> <li>2. The sampling of the inverter BUS voltage is abnormal.</li> </ol>	Disconnect the AC output switch and DC input switch, then connect them 5 minutes later. Contact the dealer or the after-sales service if the problem persists.
31	PV Input Overvoltage	The PV array configuration is not correct. Too many PV panels are connected in series in the PV string.	Check the serial connection of the PV array. Make sure that the open circuit voltage of the PV string is not higher than the maximum operating voltage of the inverter.

No.	Fault	Cause	Solutions
32	PV Continuous Hardware Overcurrent	<ol style="list-style-type: none"> <li>1. The PV configuration is not proper.</li> <li>2. The hardware is damaged.</li> </ol>	<p>Disconnect the AC output switch and DC input switch, then connect them 5 minutes later.</p> <p>Contact the dealer or the after-sales service if the problem persists.</p>
33	PV Continuous Software Overcurrent	<ol style="list-style-type: none"> <li>1. The PV configuration is not proper.</li> <li>2. The hardware is damaged.</li> </ol>	<p>Disconnect the AC output switch and DC input switch, then connect them 5 minutes later.</p> <p>Contact the dealer or the after-sales service if the problem persists.</p>
34	String1 PV String Reversed	The PV string is connected reversely.	Check whether the PV1 and PV2 strings are connected reversely.
35	String2 PV String Reversed		

### 9.5 Routine Maintenance

 <b>WARNING</b>
<ul style="list-style-type: none"> <li>• Make sure that the inverter is powered off.</li> <li>• Wear proper PPE before any operations.</li> </ul>

Maintaining Item	Maintaining Method	Maintaining Period
System Clean	Check the heat sink, air intake, and air outlet for foreign matter or dust.	Once 6-12 months
DC Switch	Turn the DC switch on and off ten consecutive times to make sure that it is working properly.	Once a year
Electrical Connection	Check whether the cables are securely connected. Check whether the cables are broken or whether there is any exposed copper core.	Once 6-12 months
Sealing	Check whether all the terminals and ports are properly sealed. Reseal the cable hole if it is not sealed or too big.	Once a year
THDi Test	For Australia requirements, in the THDi test, there should add Zref between inverter and mains. L:0.24 Ω + j0.15 Ω; N:0.16 Ω +j0.10 Ω L:0.15 Ω + j0.15 Ω ; N:0.1 Ω + j0.1 Ω	As needed

# 10 Technical Parameters

## 10.1 ES Series Technical Parameters

Technical Data	GW3000-ES-20	GW3600-ES-20	GW3600M-ES-20	GW5000-ES-20	GW5000M-ES-20	GW6000-ES-20	GW6000M-ES-20
<b>Battery Input Data</b>							
Battery Type* <sup>1</sup>	Li-Ion	Li-Ion	Li-Ion	Li-Ion	Li-Ion	Li-Ion	Li-Ion
Nominal Battery Voltage (V)	48	48	48	48	48	48	48
Battery Voltage Range (V)	40~60	40~60	40~60	40~60	40~60	40~60	40~60
Max. Continuous Charging Current (A)* <sup>1</sup>	60	75	60	120	60	120	60
Max. Continuous Discharging Current (A)* <sup>1</sup>	60	75	60	120	60	120	60
Max. Charge Power (W)* <sup>1</sup>	3,000	3,600	3,000	5,000	3,000	6,000	3,000
Max. Discharge Power (W)	3,200	3,900	3,200	5,300	3,200	6,300	3,200
<b>PV String Input Data</b>							
Max. Input Power (W)* <sup>2</sup>	4,500	5,400	5,400	7,500	7,500	9,000	9,000
Max. Input Voltage (V)	600	600	600	600	600	600	600
MPPT Operating Voltage Range (V)	60~550	60~550	60~550	60~550	60~550	60~550	60~550
MPPT Voltage Range at Nominal Power (V)	220~500	150~500	150~500	200~500	200~500	220~500	200~500

# ES G2 HYBRID SOLAR INVERTER User guide

Technical Data	GW3000-ES-20	GW3600-ES-20	GW3600M-ES-20	GW5000-ES-20	GW5000M-ES-20	GW6000-ES-20	GW6000M-ES-20
Start-up Voltage (V)	58	58	58	58	58	58	58
Nominal Input Voltage (V)	360	360	360	360	360	360	360
Max. Input Current per MPPT (A)	16	16	16	16	16	16	16
Max. Short Circuit Current per MPPT (A)	23	23	23	23	23	23	23
Max. Backfeed Current to The Array (A)	0	0	0	0	0	0	0
Number of MPP Trackers	1	2	2	2	2	2	2
Number of Strings per MPPT	1	1	1	1	1	1	1
AC Output Data (On-grid)							
Nominal Apparent Power Output to Utility Grid (VA)	3,000	3,680	3,680	5,000*3	5,000*3	6,000*3	6,000*3
Max. Apparent Power Output to Utility Grid (VA)	3,000	3,680	3,680	5,000*3	5,000*3	6,000*3	6,000*3
Nominal Apparent Power from Utility Grid (VA)	3,000	3,680	3,680	5,000	5,000	6,000	6,000
Max. Apparent Power from Utility Grid (VA)	6,000	7,360	3,680	10,000	5,000	10,000	6,000

Technical Data	GW3000-ES-20	GW3600-ES-20	GW3600M-ES-20	GW5000-ES-20	GW5000M-ES-20	GW6000-ES-20	GW6000M-ES-20
Nominal Output Voltage (V)	220 / 230 / 240	220 / 230 / 240	220 / 230 / 240	220 / 230 / 240	220 / 230 / 240	220 / 230 / 240	220 / 230 / 240
Output Voltage Range (V)	170~280	170~280	170~280	170~280	170~280	170~280	170~280
Nominal AC Grid Frequency (Hz)	50/60	50/60	50/60	50/60	50/60	50/60	50/60
AC Grid Frequency Range (Hz)	45~55 / 55~65	45~55 / 55~65	45~55 / 55~65	45~55 / 55~65	45~55 / 55~65	45~55 / 55~65	45~55 / 55~65
Max. AC Current Output to Utility Grid (A)	13.6	16.7	16.7	22.7	22.7	27.3	27.3
Max. AC Current From Utility Grid (A)	27.3	33.5	16.7	43.5	22.7	43.5	27.3
Nominal AC Current From Utility Grid (A)	13.0	16.0	16.0	21.7	21.7	26.1	26.1
Max. Output Fault Current (Peak and Duration) (A)	96A @ 3μs	96A @ 3μs	96A @ 3μs	96A @ 3μs	96A @ 3μs	96A @ 3μs	96A @ 3μs
Inrush Current (Peak and Duration) (A)	96A @ 3μs	96A @ 3μs	96A @ 3μs	96A @ 3μs	96A @ 3μs	96A @ 3μs	96A @ 3μs
Nominal Output Current (A)	13.0	16.0	16.0	21.7	21.7	26.1	26.1
Power Factor	~1 (Adjustable from 0.8 leading to 0.8 lagging)						
Max. Total Harmonic Distortion	<3%	<3%	<3%	<3%	<3%	<3%	<3%

# ES G2 HYBRID SOLAR INVERTER User guide

Technical Data	GW3000-ES-20	GW3600-ES-20	GW3600M-ES-20	GW5000-ES-20	GW5000M-ES-20	GW6000-ES-20	GW6000M-ES-20
Maximum Output Overcurrent Protection (A)	60	60	60	80	60	80	60
Type of Voltage (a.c. or d.c.)	a.c.	a.c.	a.c.	a.c.	a.c.	a.c.	a.c.
AC Output Data (Back-up)							
Back-up Nominal Apparent Power (VA)	3,000	3,680	3,680	5,000	5,000	6,000	6,000
Max. Output Apparent Power (VA)	3,000 (6,000 @10sec)	3,680 (7,360 @10sec)	3,680	5,000 (10,000 @10sec)	5,000	6,000 (10,000 @10sec)	6,000
Nominal Output Current (A)	13.0	16.0	16.0	21.7	21.7	26.1	26.1
Max. Output Current (A)	13.6	16.7	16.7	22.7	22.7	27.3	27.3
Max. Output Fault Current (Peak and Duration) (A)	96A @ 3μs	96A @ 3μs	96A @ 3μs	96A @ 3μs	96A @ 3μs	96A @ 3μs	96A @ 3μs
Inrush Current (Peak and Duration) (A)	96A @ 3μs	96A @ 3μs	96A @ 3μs	96A @ 3μs	96A @ 3μs	96A @ 3μs	96A @ 3μs
Maximum Output Overcurrent Protection (A)	60	60	60	80	60	80	60
Nominal Output Voltage (V)	220 / 230 / 240	220 / 230 / 240	220 / 230 / 240	220 / 230 / 240	220 / 230 / 240	220 / 230 / 240	220 / 230 / 240



Technical Data	GW3000-ES-20	GW3600-ES-20	GW3600M-ES-20	GW5000-ES-20	GW5000M-ES-20	GW6000-ES-20	GW6000M-ES-20
Nominal Output Frequency (Hz)	50/60	50/60	50/60	50/60	50/60	50/60	50/60
Output THDv (@Linear Load)	<3%	<3%	<3%	<3%	<3%	<3%	<3%
Efficiency							
Max. Efficiency	97.6%	97.6%	97.6%	97.6%	97.6%	97.6%	97.6%
European Efficiency	96.7%	96.7%	96.7%	96.7%	96.7%	96.7%	96.7%
CEC Efficiency	96.9%	96.9%	96.9%	96.9%	96.9%	96.9%	96.9%
Max. Battery to AC Efficiency	95.5%	95.5%	95.5%	95.5%	95.5%	95.7%	95.5%
MPPT Efficiency	99.9%	99.9%	99.9%	99.9%	99.9%	99.9%	99.9%
Protection							
PV String Current Monitoring	Integrated						
PV Insulation Resistance Detection	Integrated						
Residual Current Monitoring	Integrated						
PV Reverse Polarity Protection	Integrated						
Anti-islanding Protection	Integrated						

# ES G2 HYBRID SOLAR INVERTER User guide

Technical Data	GW3000-ES-20	GW3600-ES-20	GW3600M-ES-20	GW5000-ES-20	GW5000M-ES-20	GW6000-ES-20	GW6000M-ES-20
AC Overcurrent Protection	Integrated						
AC Short Circuit Protection	Integrated						
AC Overvoltage Protection	Integrated						
DC Switch	Integrated						
DC Surge Protection	Type II						
AC Surge Protection	Type III						
AFCI	Optional						
Remote Shutdown	Integrated						
General Data							
Operating Temperature Range (°C)	-25~+60						
Relative Humidity	0~95%						
Max. Operating Altitude (m)	3000 (>2000 derating)						
Cooling Method	Natural Convection						
User Interface	LED, WLAN+APP						
Communication with BMS	CAN						
Communication with Meter	RS485						
Communication with Portal	WiFi / WiFi + LAN / 4G						

Technical Data	GW3000-ES-20	GW3600-ES-20	GW3600M-ES-20	GW5000-ES-20	GW5000M-ES-20	GW6000-ES-20	GW6000M-ES-20
Weight (kg)	19.6	20.8	20.0	21.5	20.0	21.5	20.0
Dimension (W×H×D mm)	505.9×434.9×154.8						
Noise Emission (dB)	<30						
Topology	Non-isolated						
Self-consumption at Night (W)	<10						
Ingress Protection Rating	IP65						
DC Connector	MC4, VACONN Terminal						
AC Connector	VACONN Terminal						
Environmental Category	4K4H						
Pollution Degree	III						
Overvoltage Category	DC II / AC III						
Protective Class	I						
Storage Temperature (°C)	-40~+85						
The Decisive Voltage Class (DVC)	Battery: A PV: C AC: C Com: A						
Mounting Method	Wall Mounted						
Active Anti-islanding Method	SMS (Slip-mode frequency) +AFD						

# ES G2 HYBRID SOLAR INVERTER User guide

Technical Data	GW3000-ES-20	GW3600-ES-20	GW3600M-ES-20	GW5000-ES-20	GW5000M-ES-20	GW6000-ES-20	GW6000M-ES-20
Type of Electrical Supply System	single phase						
Country of Manufacture	China						
Certifications & Standards*4							
Grid Standards	AS4777.2-2020; NRS 097-2-1; CEI 0-21						
Safety Regulation	IEC62109-1&2						
EMC	IEC 61000-6-1/2/3/4; IEC61000-4-16/18/29; IEC 61000-2-2,CISPR 11; EN300328; EN301489; EN IEC 62311						
<p>*1: The actual charge and discharge current/power also depends on the battery.</p> <p>*2: The max power is the actual power of PV.</p> <p>*3: 4600 for VDE-AR-N4105 &amp; NRS 097-2-1.</p> <p>*4: Not all certifications &amp; standards listed, check the official website for details.</p>							

Technical Data	GW6000-ES-BR20	GW3500L-ES-BR20	GW3600-ES-BR20
<b>Battery Input Data</b>			
Battery Type* <sup>1</sup>	Li-Ion/Lead-acid	Li-Ion/Lead-acid	Li-Ion/Lead-acid
Nominal Battery Voltage (V)	48	48	48
Battery Voltage Range (V)	40~60	40~60	40~60
Start-up Voltage (V)	40	40	40
Number of Battery Input	1	1	1
Max. Continuous Charging Current (A)	120	75	75
Max. Continuous Discharging Current (A)	120	75	75
Max. Charge Power (W)	6,000	3,500	3,600
Max. Discharge Power (W)	6,300	3,800	3,900
<b>PV String Input Data</b>			
Max. Input Power (W) * <sup>2</sup>	10,800	6,300	6,480
Max. Input Voltage (V)	600	600	600
MPPT Operating Voltage Range (V)	60~550	60~550	60~550
MPPT Voltage Range at Nominal Power (V)	220~500	150~500	150~500
Start-up Voltage (V)	58	58	58
Nominal Input Voltage (V)	360	360	360
Max. Input Current per MPPT (A)	16	16	16
Max. Short Circuit Current per MPPT (A)	23	23	23
Max. Backfeed Current to The Array (A)	0	0	0
Number of MPP Trackers	2	2	2
Number of Strings per MPPT	1	1	1
<b>AC Output Data (On-grid)</b>			
Nominal Output Power (W)	6000	3500	3680
Max. Output Power (W)	6000	3500	3680
Nominal Apparent Power Output to Utility Grid (VA)	6000	3500	3680
Max. Apparent Power Output to Utility Grid (VA)	6000	3500	3680
Nominal Power at 40°C (W)* <sup>3</sup>	6000	3500	3680

# ES G2 HYBRID SOLAR INVERTER User guide

Technical Data	GW6000-ES-BR20	GW3500L-ES-BR20	GW3600-ES-BR20
Max. Power at 40°C (Including AC Overload) (W)*3			
	6000	3500	3680
Nominal Apparent Power from Utility Grid (VA)	6000	3500	3680
Max. Apparent Power from Utility Grid (VA)	10,000	5500	7360
Nominal Output Voltage (V)	220	127	220
Output Voltage Range (V)	165~280	95~165	165~280
Nominal AC Grid Frequency (Hz)	60	60	60
AC Grid Frequency Range (Hz)	45~55 / 55~65	55~65	45~55 / 55~65
Max. AC Current Output to Utility Grid (A)	27.3	27.6	16.7
Max. AC Current From Utility Grid (A)	43.5	43.5	33.5
Max. Output Fault Current (Peak and Duration) (A)	96A@3μs	96A@3μs	96A@3μs
Inrush Current (Peak and Duration) (A)	96A@3μs	96A@3μs	96A@2μs
Nominal Output Current (A)	27.3	27.6	16.7
Power Factor	~1 (Adjustable from 0.8 leading to 0.8 lagging)		
Max. Total Harmonic Distortion	<3%	<3%	<3%
Maximum Output Overcurrent Protection (A)	80	80	60
<b>AC Output Data (Back-up)</b>			
Back-up Nominal Apparent Power (VA)	6,000	3,500	3,680
Max. Output Apparent Power (VA)	6,000 (10000@10s)	3,500 (5800@10s)	3,680 (7360@10s)
Max. Output Apparent Power with Grid (VA)	6000	3500	3680
Nominal Output Current (A)	27.3	27.6	16.7
Max. Output Current (A)	27.3	27.6	16.7
Max. Output Fault Current (Peak and Duration) (A)	96A@3μs	96A@3μs	96A@3μs

Technical Data	GW6000-ES-BR20	GW3500L-ES-BR20	GW3600-ES-BR20
Inrush Current (Peak and Duration) (A)	96A@3 $\mu$ s	96A@3 $\mu$ s	96A@3 $\mu$ s
Maximum Output Overcurrent Protection (A)	80	80	60
Nominal Output Voltage (V)	220	127	220
Nominal Output Frequency (Hz)	60	60	60
Output THDv (@Linear Load)	<3%	<3%	<3%
Switching from Grid Connected Mode to Standalone Mode	<10ms	<10ms	<10ms
Switching from Standalone Mode to Network Connected Mode	<10ms	<10ms	<10ms
Efficiency			
Max. Efficiency	97.60%	96.00%	97.60%
European Efficiency	96.70%	95.60%	96.70%
Max. Battery to AC Efficiency	95.70%	94.00%	95.50%
MPPT Efficiency	99.90%	99.90%	99.90%
Protection			
PV String Current Monitoring	Integrated		
PV Insulation Resistance Detection	Integrated		
Residual Current Monitoring	Integrated		
PV Reverse Polarity Protection	Integrated		
Anti-islanding Protection	Integrated		
AC Overcurrent Protection	Integrated		
AC Short Circuit Protection	Integrated		
AC Overvoltage Protection	Integrated		
DC Switch	Integrated		
DC Surge Protection	Type II		
AC Surge Protection	Type III		
AFCI	Optional		
Remote Shutdown	Integrated		
General Data			

# ES G2 HYBRID SOLAR INVERTER User guide

Technical Data	GW6000-ES-BR20	GW3500L-ES-BR20	GW3600-ES-BR20
Operating Temperature Range (°C)	-25~+60	-25~+60	-25~+60
Max. Operating Altitude (m)	3000 (>2000 derating)	3000 (>2000 derating)	3000 (>2000 derating)
Cooling Method	Natural Convection		
User Interface	LED, WLAN+APP		
Communication with BMS	CAN	CAN	CAN
Communication with Meter	RS485	RS485	RS485
Communication with Portal	WiFi / WiFi +LAN / 4G		
Weight (kg)	21.5	21.5	20.8
Dimension (W×H×D mm)	505.9×434.9×154.8		
Noise Emission (dB)	<30	<30	<30
Topology	Non-isolated	Non-isolated	Non-isolated
Self-consumption at Night (W)	<10	<10	<10
Ingress Protection Rating	IP65	IP65	IP65
DC Connector	MC4, VACONN Terminal		
AC Connector	VACONN Terminal		
Environmental Category	4K4H	4K4H	4K4H
Pollution Degree	III	III	III
Overvoltage Category	DC II / AC III	DC II / AC III	DC II / AC III
Protective Class	I	I	I
Storage Temperature (°C)	-40~+85	-40~+85	-40~+85
The Decisive Voltage Class (DVC)	Battery: A PV: C AC: C Com: A		
Mounting Method	Wall Mounted		
Active Anti-islanding Method	SMS (Slip-mode frequency) +AFD		
Type of Electrical Supply System	single phase		
Country of Manufacture	China		
Certification*4			
Grid Standards	N140		



Technical Data	GW6000-ES-BR20	GW3500L-ES-BR20	GW3600-ES-BR20
Safety Regulation	IEC62109-1&2		
EMC	IEC 61000-6-1/2/3/4; IEC61000-4-16/18/29; IEC 61000-2-2,CISPR 11; EN300328; EN301489; EN IEC 62311		
<p>*1: The actual charge and discharge current/power also depends on the battery.</p> <p>*2: For most of the PV module, the max. Input power can achieve 2Pn, Such as the max. input power of GW6000-ES-BR20 can achieve 12000W</p> <p>*3 The nominal Power at 40°C and Max. Power at 40°C are only for Brazil.</p> <p>*4: Not all certifications &amp; standards listed, check the official website for details.</p>			

### 10.2 SBP Series Technical Parameters

Technical Data	GW3600-SBP-20	GW5000-SBP-20	GW6000-SBP-20
<b>Battery Input Data</b>			
Battery Type*1	Li-Ion	Li-Ion	Li-Ion
Nominal Battery Voltage (V)	48	48	48
Battery Voltage Range (V)	40~60	40~60	40~60
Max. Continuous Charging Current (A)*1	75	120	120
Max. Continuous Discharging Current (A)*1	75	120	120
Max. Charge Power (W)*1	3,600	5,000	6,000
Max. Discharge Power (W)	3,900	5,300	6,300
<b>AC Output Data (On-grid)</b>			
Nominal Apparent Power Output to Utility Grid (VA)	3,680	5,000*2	6,000*2
Max. Apparent Power Output to Utility Grid (VA)	3,680	5,000*2	6,000*2
Nominal Apparent Power from Utility Grid (VA)	3,680	5,000	6,000
Max. Apparent Power from Utility Grid (VA)	7,360	10,000	10,000
Nominal Output Voltage (V)	220/230/240	220/230/240	220/230/240
Output Voltage Range (V)	170~280	170~280	170~280
Nominal AC Grid Frequency (Hz)	50/60	50/60	50/60
AC Grid Frequency Range (Hz)	45~55 / 55~65	45~55 / 55~65	45~55 / 55~65
Max. AC Current Output to Utility Grid (A)	16.7	22.7	27.3
Max. AC Current From Utility Grid (A)	33.5	43.5	43.5
Nominal AC Current From Utility Grid (A)	16.0	21.7	26.1
Max. Output Fault Current (Peak and Duration) (A)	96A@3μs	96A@3μs	96A@3μs
Inrush Current (Peak and Duration) (A)	96A@3μs	96A@3μs	96A@3μs
Nominal Output Current (A)	16.0	21.7	26.1
Power Factor	~1 (Adjustable from 0.8 leading to 0.8 lagging)		
Max. Total Harmonic Distortion	<3%	<3%	<3%

Technical Data	GW3600-SBP-20	GW5000-SBP-20	GW6000-SBP-20
Maximum Output Overcurrent Protection (A)	60	80	80
Type of Voltage (a.c. or d.c.)	a.c.	a.c.	a.c.
AC Output Data (Back-up)			
Back-up Nominal Apparent Power (VA)	3,680	5,000	6,000
Max. Output Apparent Power (VA)	3,680 (7,360@10sec)	5,000 (10,000 @ 10sec)	6,000 (10,000 @ 10sec)
Nominal Output Current (A)	16.0	21.7	26.1
Max. Output Current (A)	16.7	22.7	27.3
Max. Output Fault Current (Peak and Duration) (A)	96A @ 3μs	96A @ 3μs	96A @ 3μs
Inrush Current (Peak and Duration) (A)	96A @ 3μs	96A @ 3μs	96A @ 3μs
Maximum Output Overcurrent Protection (A)	60	80	80
Nominal Output Voltage (V)	220 / 230 / 240	220 / 230 / 240	220 / 230 / 240
Nominal Output Frequency (Hz)	50/60	50/60	50/60
Output THDv (@Linear Load)	<3%	<3%	<3%
Efficiency			
Max. Battery to AC Efficiency	95.5%	95.5%	95.5%
Protection			
Residual Current Monitoring	Integrated	Integrated	Integrated
Anti-islanding Protection	Integrated	Integrated	Integrated
AC Overcurrent Protection	Integrated	Integrated	Integrated
AC Short Circuit Protection	Integrated	Integrated	Integrated
AC Overvoltage Protection	Integrated	Integrated	Integrated
AC Surge Protection	Type III	Type III	Type III
Remote Shutdown	Integrated	Integrated	Integrated
General Data			
Operating Temperature Range (°C)	-25~+60	-25~+60	-25~+60
Relative Humidity	0~95%	0~95%	0~95%
Max. Operating Altitude (m)	3000 (>2000 derating)		
Cooling Method	Natural Convection		
User Interface	LED, WLAN+APP		

# ES G2 HYBRID SOLAR INVERTER User guide

Technical Data	GW3600-SBP-20	GW5000-SBP-20	GW6000-SBP-20
Communication with BMS	CAN		
Communication with Meter	RS485		
Communication with Portal	WiFi / WiFi + LAN / 4G		
Weight (kg)	19.2	19.5	19.5
Dimension (W×H×D mm)	505.9×434.9×154.8		
Noise Emission (dB)	<30	<30	<30
Topology	Isolated	Isolated	Isolated
Self-consumption at Night (W)	<10	<10	<10
Ingress Protection Rating	IP65	IP65	IP65
DC Connector	MC4, VACONN Terminal		
AC Connector	VACONN	VACONN	VACONN
Environmental Category	4K4H	4K4H	4K4H
Pollution Degree	III	III	III
Overvoltage Category	AC III	AC III	AC III
Protective Class	I	I	I
Storage Temperature (°C)	-40~+85	-40~+85	-40~+85
The Decisive Voltage Class (DVC)	Battery: A AC: C Com: A		
Mounting Method	Wall Mounted		
Active Anti-islanding Method	SMS (Slip-mode frequency) +AFD		
Type of Electrical Supply System	Single phase		
Country of Manufacture	China		
*1: The actual charge and discharge current/power also depends on the battery.			
*2: 4600 for VDE-AR-N4105 & NRS 097-2-1.			





## Tell me more

Call 01283 722588

Email [info@marley.co.uk](mailto:info@marley.co.uk)

Or visit [marley.co.uk](http://marley.co.uk)

Marley, Lichfield Road, Branston, Burton upon Trent, DE14 3HD

V1.0 01.02.2024

