

Solar PV Single Phase Inverter

(MACSI3600 | MACSI5000 | MACSI6000)



General Disclaimer

- The information in this quick installation guide is subject to change due to product updates or other reasons. This guide cannot replace the product labels or the safety precautions in the user manual unless otherwise specified. All descriptions here are for guidance only.
- Before installations, read through the quick installation guide. For additional information, please see the user manual.
- All operations should be performed by trained and knowledgeable technicians who are familiar with local standards and safety regulations.
- Check the deliverables for correct model, complete contents, and intact appearance. Contact the manufacturer if any damage is found or any component is missing.
- Use insulating tools and wear personal protective equipment when operating the equipment to ensure personal safety. Wear anti-static gloves, clothes, and wrist strip when touching electronic components to protect the inverter from damage. The manufacturer shall not be liable for any damage caused by static electricity.
- Strictly follow the installation, operation, and configuration instructions in this guide and user manual. The manufacturer shall not be liable for equipment damage or personal injury if you do not follow the instructions.

Safety Disclaimer



Warning

DC Side:









1. Ensure the component frames and the bracket system are securely grounded.
2. Connect the DC cables using the delivered PV connectors. The manufacturer shall not be liable for equipment damage if other connectors are used.
3. Ensure the DC cables are connected tightly, securely, and correctly. Inappropriate wiring may cause poor contacts or high impedances, and damage the inverter.
4. Measure the DC cable using the multimeter to avoid reverse polarity connection. Also, the voltage should be under the max DC input voltage. The manufacturer shall not be liable for the damage caused by reverse connection and extremely high voltage.
5. The PV modules used with the inverter must have an IEC61730 class A rating.

AC Side:

1. The voltage and frequency at the connecting point should meet the on-grid requirements.
2. Additional protective devices like circuit breakers or fuses are recommended on the AC side. Specification of the protective device should be at least 1.25 times the rated AC output rated current.
3. PE cable of the inverter must be connected firmly.
4. You are recommended to use copper cables as AC output cables. If you prefer aluminum cables, remember to use copper to aluminum adapter terminals.

Product:

1. Do not apply mechanical load to the terminals, otherwise the terminals can be damaged.
2. All labels and warning marks should be visible after the installation. Do not scrawl, damage, or cover any label on the device.
3. Unauthorized dismantling or modification may damage the equipment, the damage is not covered under the warranty.
4. Install the inverter away from high magnetic field to avoid electromagnetic interference. If there is any radio or wireless communication equipment below 30MHz near the inverter, you have to:
 - Install the inverter at least 30m far away from the wireless equipment.
 - Add a low pass EMI filter or a multi winding ferrite core to the DC input cable or AC output cable of the inverter.
5. Warning labels on the inverter are as follows.

	HIGH VOLTAGE HAZARD. Disconnect all incoming power and turn off the product before working on it.		Delayed discharge. Wait 5 minutes after power off until the components are completely discharged.
	Read through the guide before working on this device.		Potential risks exist. Wear proper PPE before any operations.
	High-temperature hazard. Do not touch the product under operation to avoid being burnt.		Grounding point. Indicates the position for connecting the PE cable.
	CE marking		Do not dispose of the inverter as household waste. Discard the product in compliance with local laws and regulations, or send it back to the manufacturer.

Check before Power-on

No.	Check Item
1	The product is firmly installed at a clean place that is well-ventilated and easy-to-operate.
2	The PE, DC input, AC output, and communication cables are connected correctly and securely.
3	Cable ties are intact, routed properly and evenly.
4	Unused ports and terminals are sealed.
5	The voltage and frequency at the connection point meet the inverter grid connection requirements.

EU Declaration of Conformity

Viridian Solar Ltd. hereby declares that the inverter with wireless communication modules sold in the European market meets the requirements of the following directives:













- Radio Equipment Directive 2014/53/EU (RED)
- Restrictions of Hazardous Substances Directive 2011/65/EU and (EU) 2015/863 (RoHS)
- Waste Electrical and Electronic Equipment 2012/19/EU
- Registration, Evaluation, Authorization and Restriction of Chemicals (EC) No 1907/2006 (REACH)

Viridian Solar Ltd. hereby declares that the inverter without wireless communication modules sold in the European market meets the requirements of the following directives:



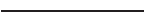















- Electromagnetic compatibility Directive 2014/30/EU (EMC)
- Electrical Apparatus Low Voltage Directive 2014/35/EU (LVD)
- Restrictions of Hazardous Substances Directive 2011/65/EU and (EU) 2015/863 (RoHS)
- Waste Electrical and Electronic Equipment 2012/19/EU
- Registration, Evaluation, Authorization and Restriction of Chemicals (EC) No 1907/2006 (REACH)

LED Indicators

Inverters Designed with LCD

Indicator	Status	Description
		ON = Wi-Fi IS CONNECTED/ACTIVE
		BLINK 1 = Wi-Fi SYSTEM IS RESETTING
		BLINK 2 = NOT CONNECTED TO THE ROUTER
		BLINK 4 = Wi-Fi SERVER PROBLEM
		BLINK = RS485 IS CONNECTED
		OFF = Wi-Fi IS NOT ACTIVE
		ON = THE INVERTER IS FEEDING POWER
		OFF = THE INVERTER IS NOT FEEDING POWER AT THE MOMENT
		ON = A FAULT HAS OCCURRED
		OFF = NO FAULT

Inverters Designed without LCD

Indicator	Status	Description
		ON = EQUIPMENT POWER ON
		OFF = EQUIPMENT POWER OFF
		ON = THE INVERTER IS FEEDING POWER
		OFF = THE INVERTER IS NOT FEEDING POWER
		SINGLE SLOW FLASH = SELF CHECK BEFORE CONNECTING TO THE GRID
		SINGLE FLASH = CONNECTING TO THE GRID
		ON = WIRELESS IS CONNECTED/ACTIVE
		BLINK 1 = WIRELESS SYSTEM IS RESETTING
		BLINK 2 = WIRELESS ROUTER PROBLEM
		BLINK 4 = WIRELESS SERVER PROBLEM
		BLINK = RS485 IS CONNECTED
		OFF = WIRELESS IS NOT ACTIVE
		ON = A FAULT HAS OCCURRED
		OFF = NO FAULT

Parts

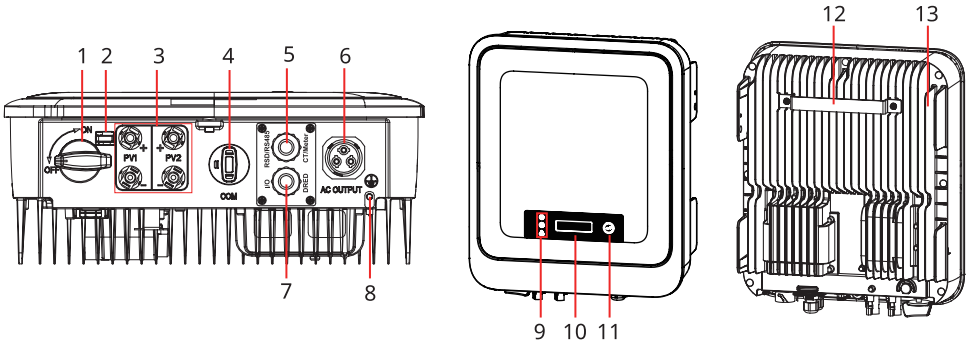

- | | | |
|--|--|-----------------------|
| 1. DC Switch | 2. DC switch Locking Hole ^[1] | 3. PV Input Terminal |
| 4. Communication Module/RS485-USB Cable Port | 5. RS485/Remote Shutdown/CT/Meter Communication Cable Port | 6. AC Output Terminal |
| 7. DRED/Dry Contact Communication Cable Port | 8. PE Terminal | 9. Indicator |
| 10. LCD(optional) | 11. Button(optional) | 12. Mounting Plate |
| 13. Heat Sink | | |

[1] For Australia only.

Dimensions

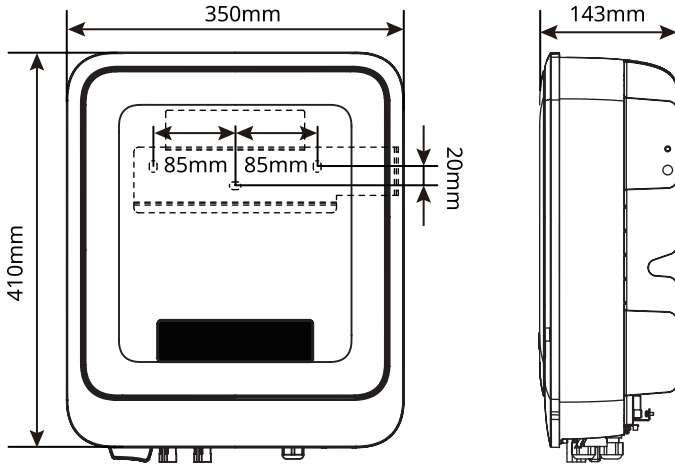

03 Inverter Installation

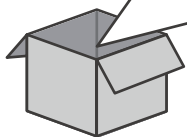
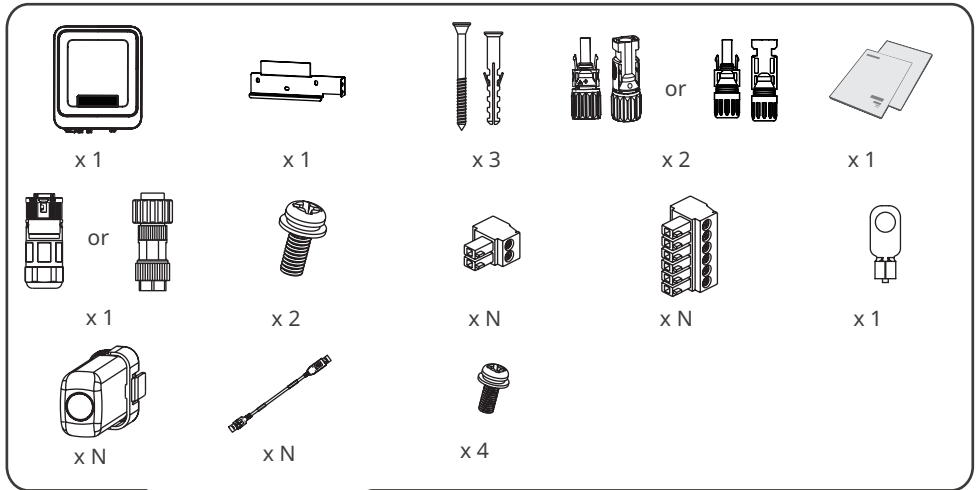

N = Quantity depends on the inverter model.

Space Requirements

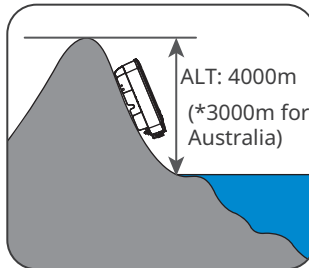
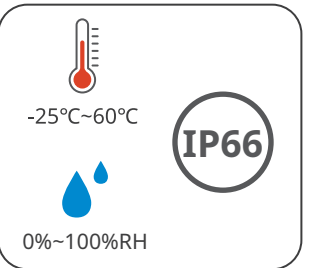
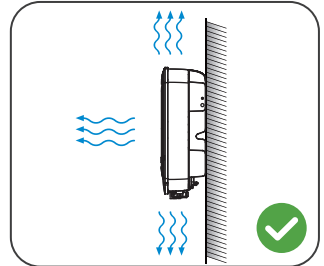
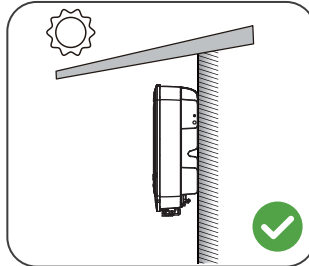
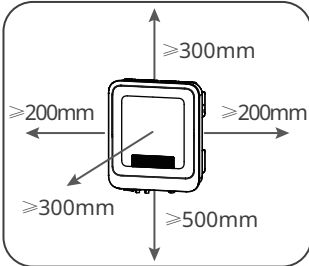
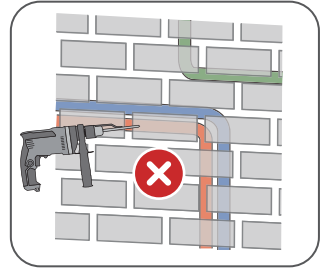
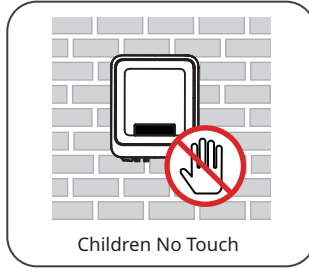

Angle Requirements

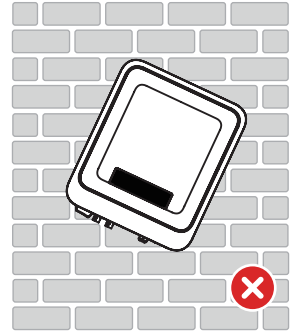
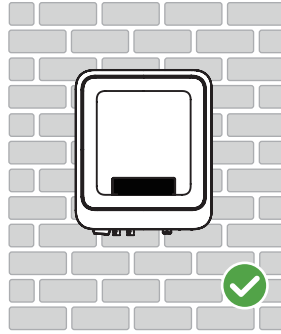
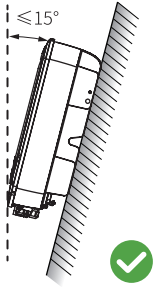

Installing the Inverter

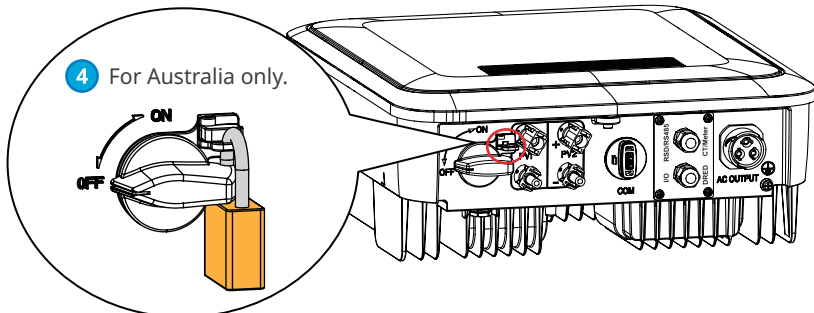
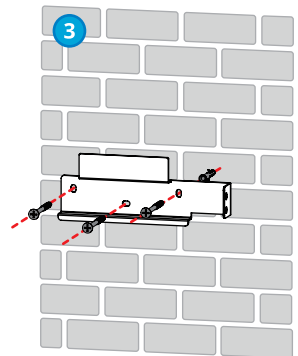
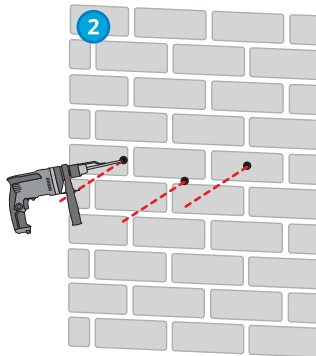
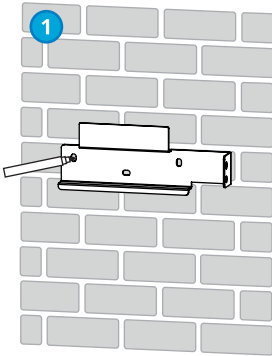

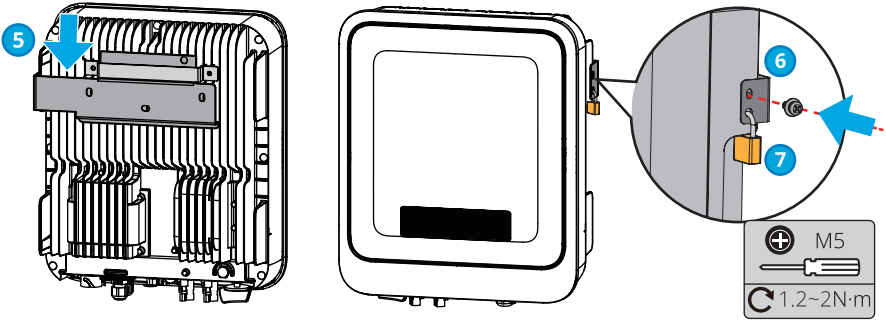

04 Electrical Connection

PE Cable

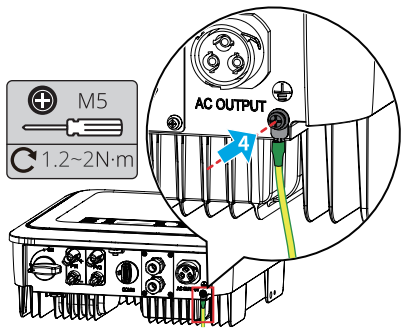
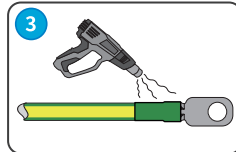
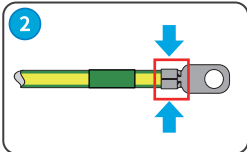
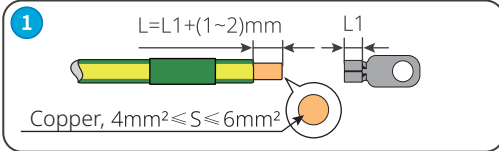

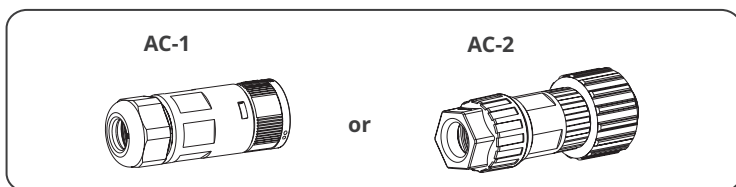
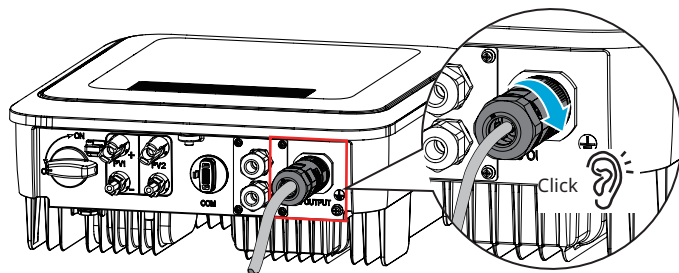

AC-1

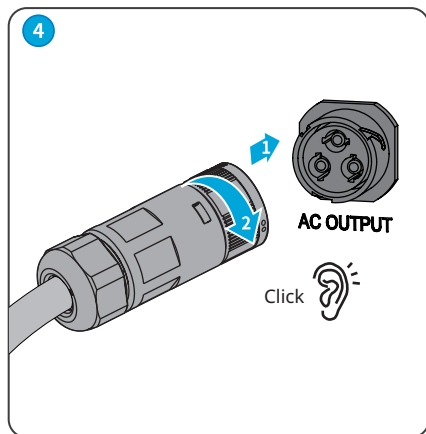
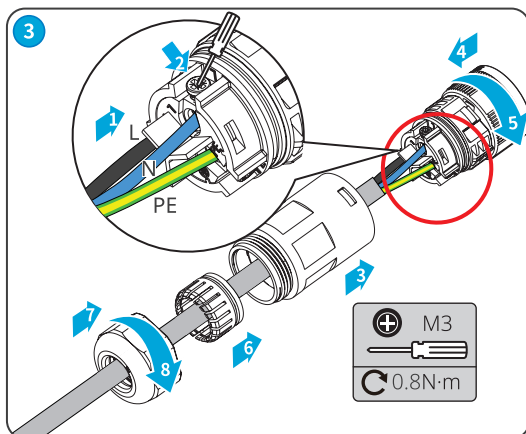
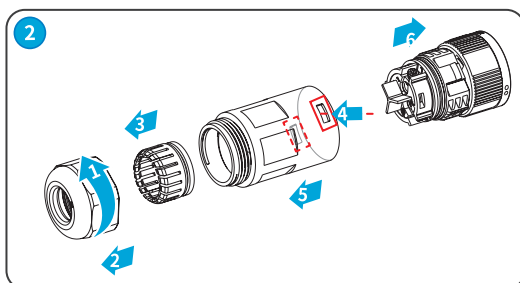
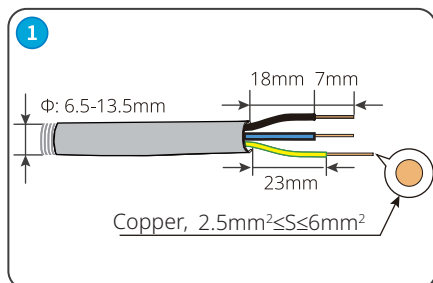

AC-2

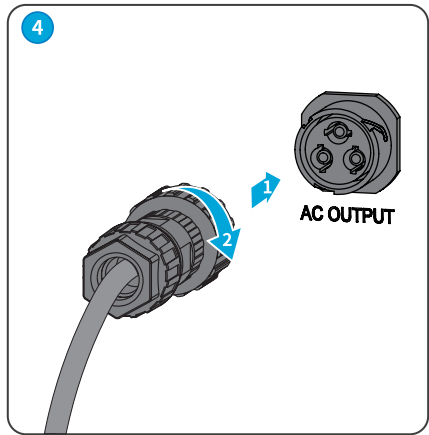
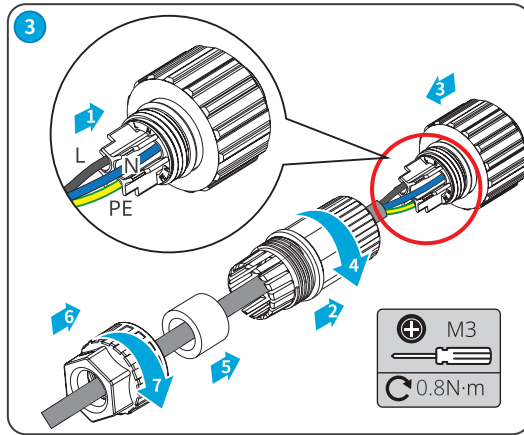
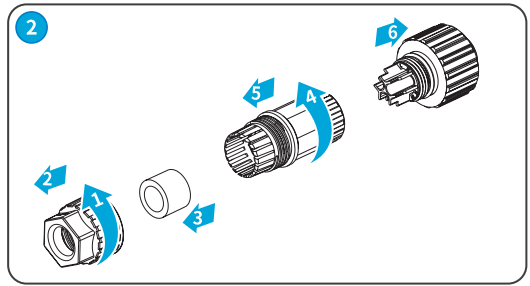
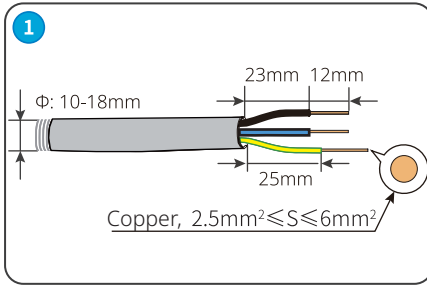

DC Cable

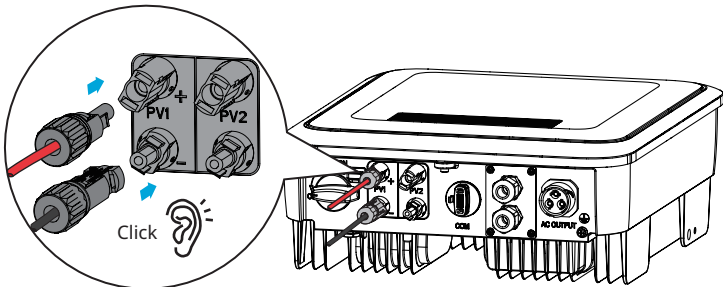

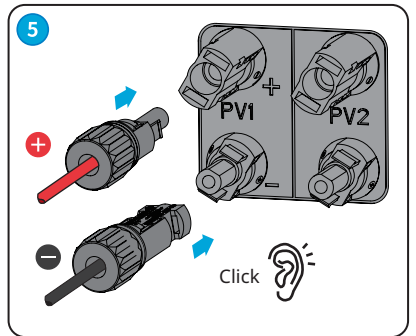
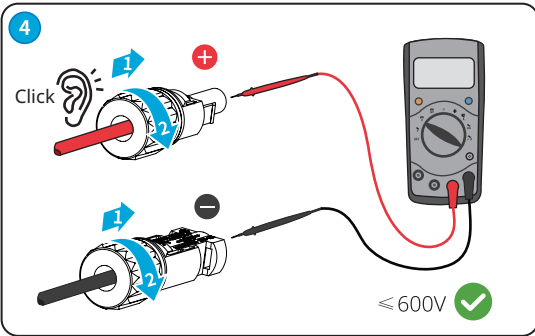
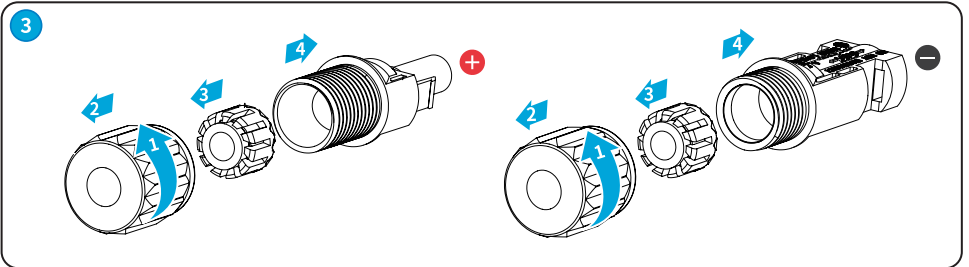
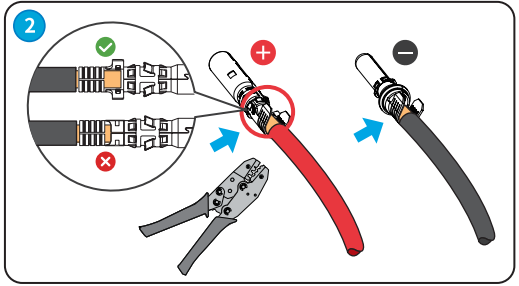
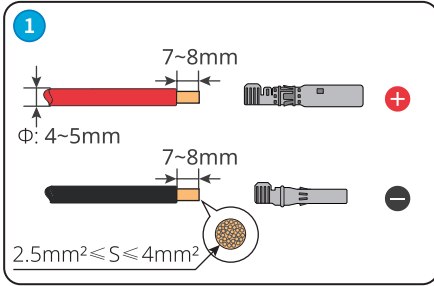

Staubli MC4

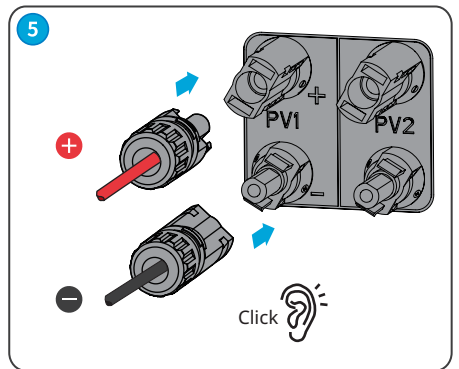
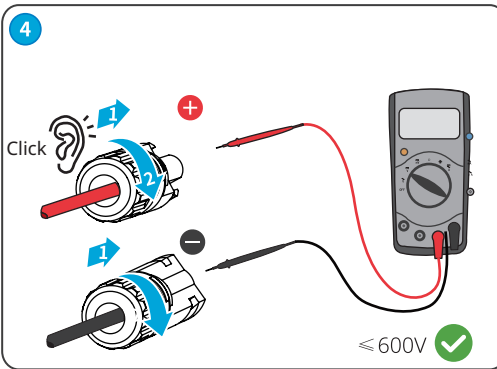
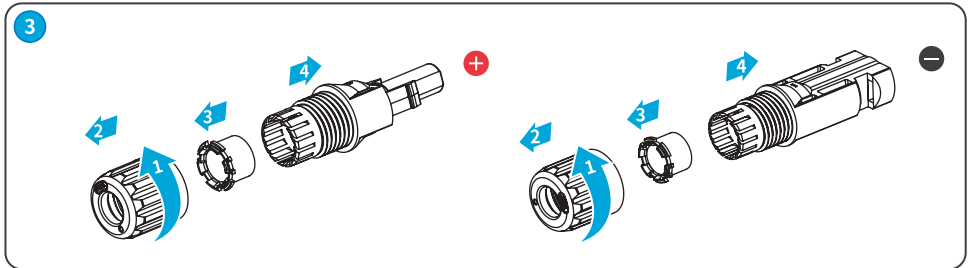
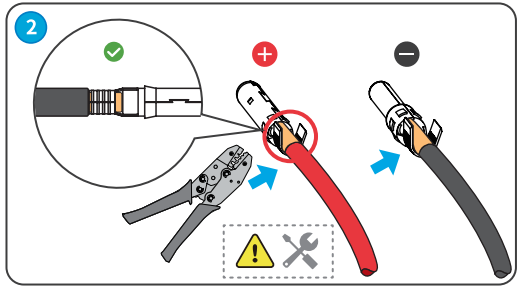
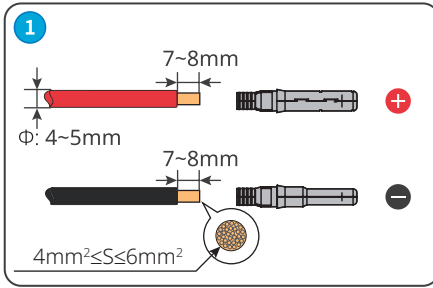

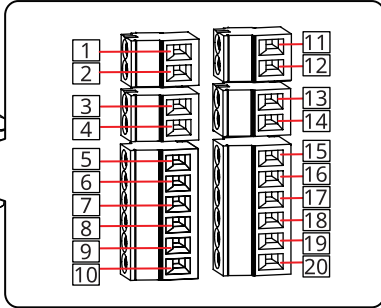
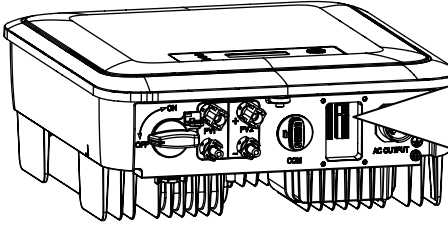

PIN	Function	Definition	PIN	Function	Definition
1	RS485	RS485+	11	Meter	Meter+
2		RS485-	12		Meter-
3	Remote Shutdown (For Europe only) or Rapid ShutDown (For North America only) or Emergency Power Off(For India only)	RSD+	13	CT	CT+
4		RSD-	14		CT-
5	Dry Contact	I/O1+	15	DRED (For Australia only.)	DRM1/5
6		I/O1-	16		DRM2/6
7		I/O2+	17		DRM3/7
8		I/O2-	18		DRM4/8
9		I/O3+	19		REFGEN
10		I/O3-	20		COM/DRM0

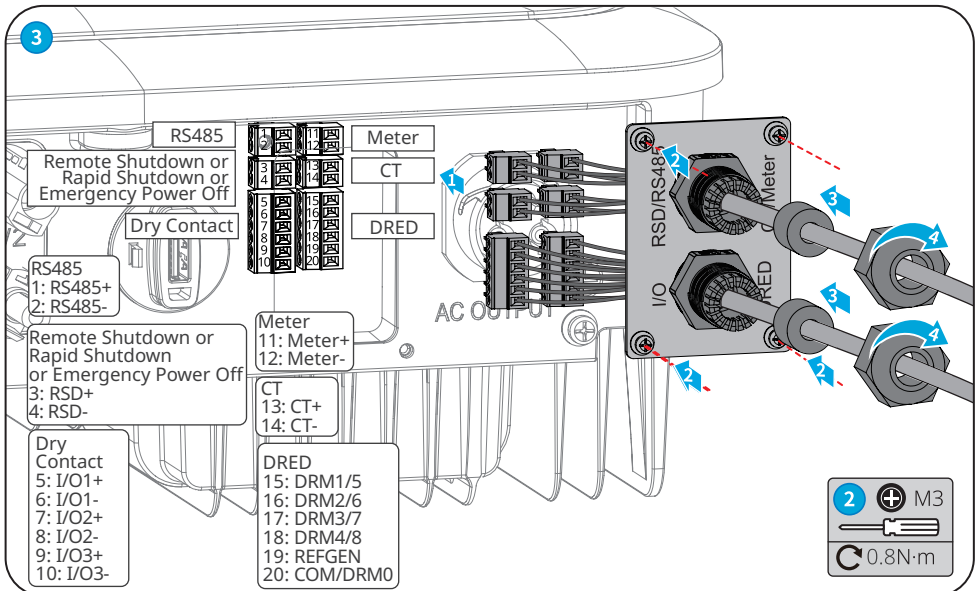
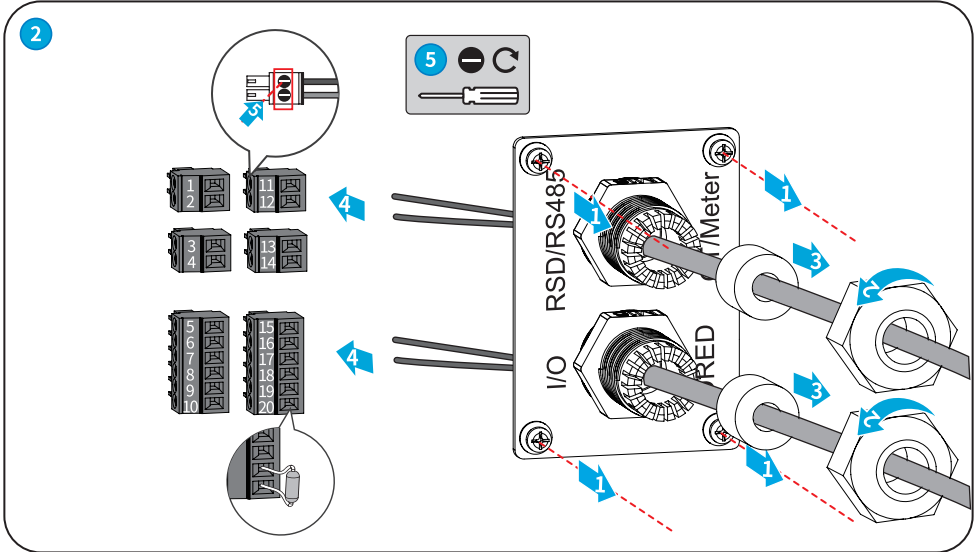
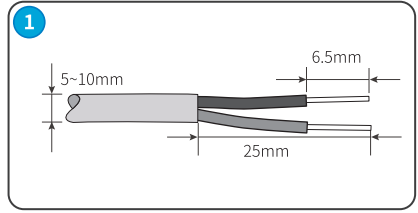
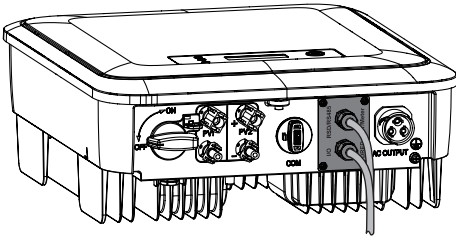

Communication Module

WiFi kit, LAN kit, 4G kit, GPRS, Bluetooth Kit, Wi-Fi/LAN Kit module: optional.

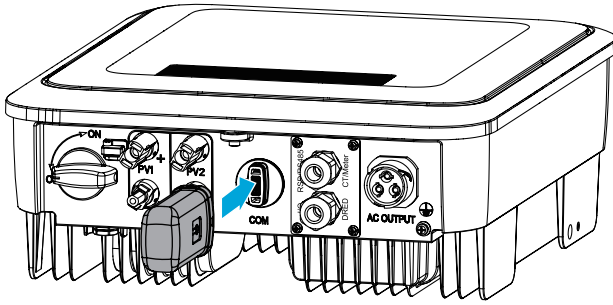

RS485-USB Cable: Brazil.

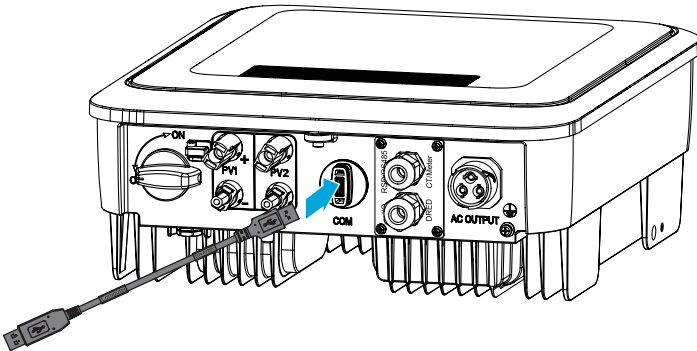

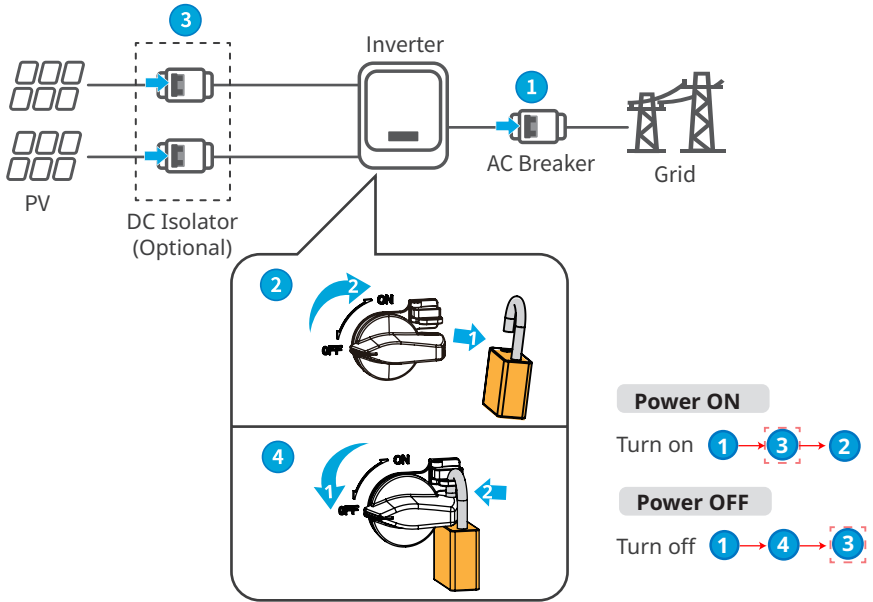

For Australia only.

06 Commissioning

Commissioning via LCD

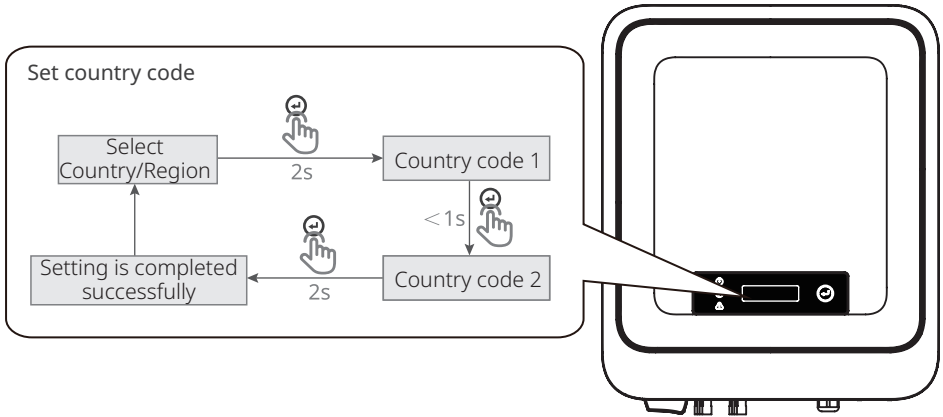

Commissioning via WE Mate APP

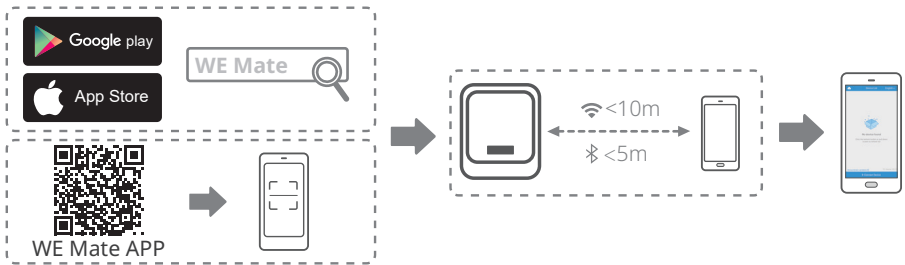

Monitoring via Solar Portal App

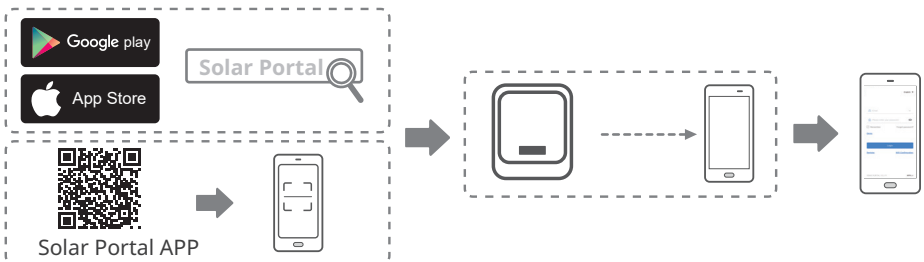



Tell me more



Call 01283 722588

Email info@marley.co.uk

Or visit www.marley.co.uk