



▲ CLAY PLAIN TILES



CONTENTS

- 4 CLAY PLAIN TILE ROOF SYSTEMS
- 6 INNOVATION IN CLAY
- 8 CANTERBURY HANDMADE
- 12 ACME SINGLE CAMBER STANDARD
- 26 ACME SINGLE CAMBER HERITAGE
- 30 HAWKINS MACHINE-MADE
- 38 DETAILING CLAY PLAIN TILE ROOF SYSTEMS
- 40 BASE LAYERS
- 42 FITTINGS & ACCESSORIES
- 46 PROPERTIES & PERFORMANCE
- 48 DESIGN DETAILS
- 60 HERE TO HELP

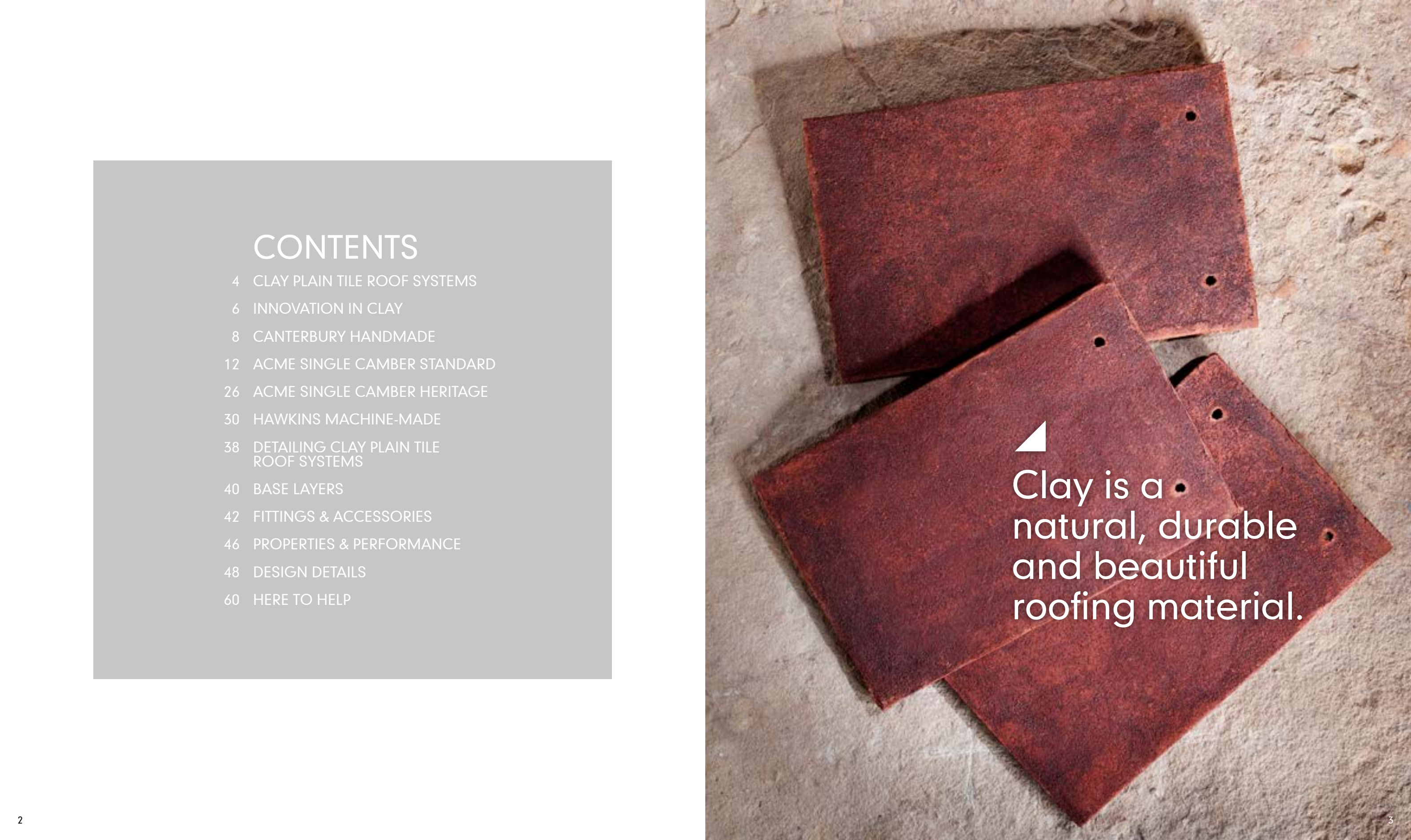

▲
Clay is a natural, durable and beautiful roofing material.

CLAY PLAIN TILE ROOF SYSTEMS

- ▲ We offer the most comprehensive roof system on the market today, underwritten by a 15 year warranty. Our complete, one-source roof system, gives levels of accountability and product integration that reduce specifier and contractor design and installation liability. More elements guaranteed to work seamlessly together, give you more time to focus on design and management of your project, complete peace of mind and, of course, better, easier-to-install, more durable, lower maintenance roofs.

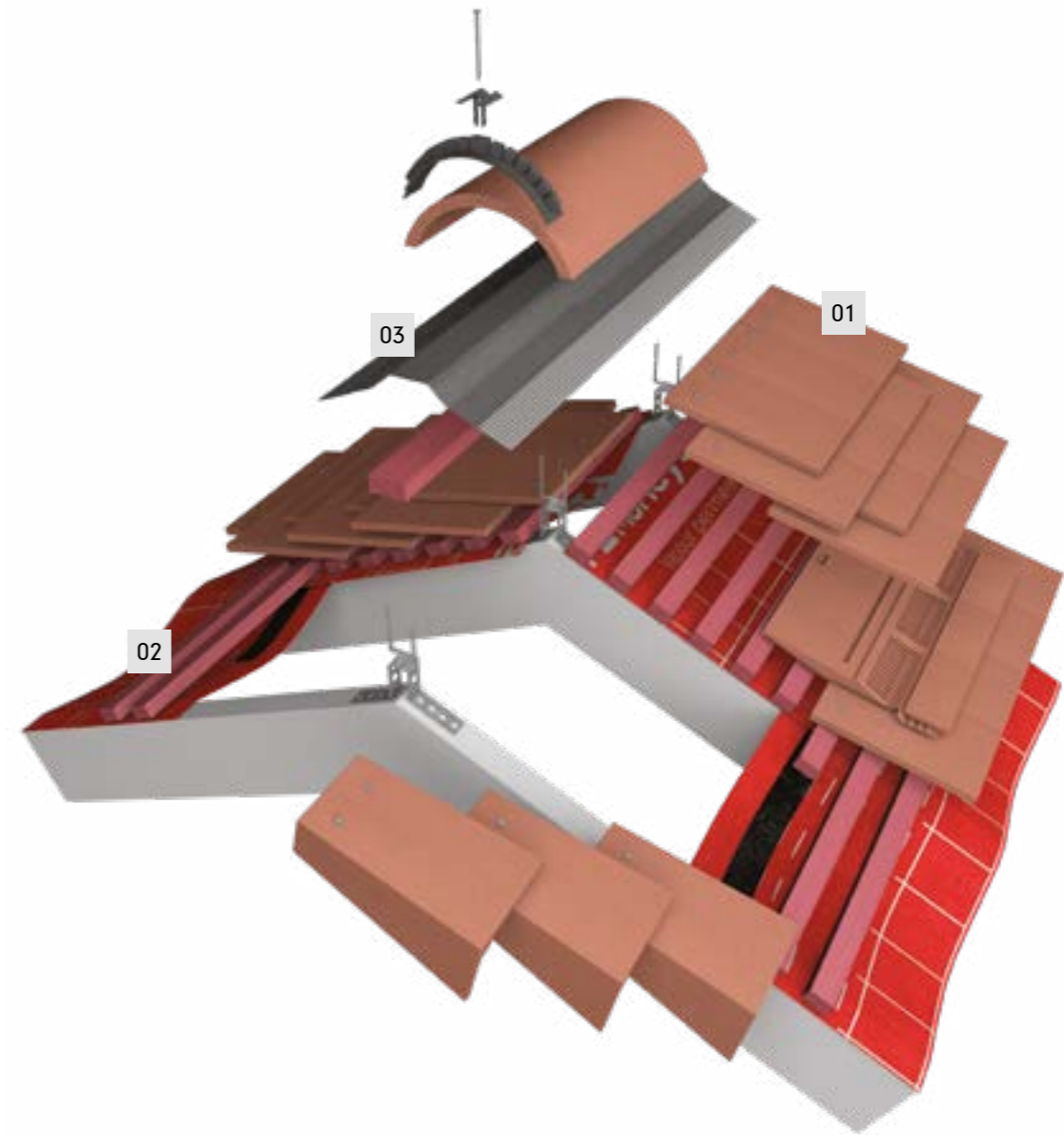

01/ ROOF COVERINGS

A range of clay plain tiles to suit every sector, pitch, geographical location and aesthetic requirement: at the same time complying with BS 5534 and BS 5250 and fully integrating with our base layers and dry fix systems to create a complete roof system.

- ▲ Clay plain tile range (pages 8-37)
- ▲ Properties and performance (pages 46-47)
- ▲ Case studies pages (11, 16, 21, 24 and 34)

02/ BASE LAYERS

With Universal permeable or non-breathable fully taped underlay and JB Red pre-graded BBA-certified battens, we offer BS 5534-compliant NHBC approved base layers that work seamlessly with all the other elements of our roof systems.

- ▲ Universal underlays (page 40)
- ▲ JB-Red battens (page 41)

03/ DETAILING

Dry fix BS 5534 and BS 5250-compliant systems for eaves, verge, valley hip, ridge abutment and other areas. These systems are made from high quality materials and tested together to work with our clay plain tile and other roof coverings to give secure, weathertight and durable finishing and detailing for our roof systems.

- ▲ Dry fix and ventilation systems (pages 38-39)
- ▲ Fittings and accessories (pages 42-45)
- ▲ Design details pages (pages 48-59)

KNOWLEDGE

A key part of our roof system is ease of access to tools and knowledge that make the design, specification and fixing process easier and faster. Our suite of free-to-use online tools is designed to get our knowledge into your designs and specs quickly and easily.

- ▲ Resources (pages 60-61)

WARRANTY

Our 15 year warranty covers more pitched roofing elements than any other manufacturer and gives the ultimate assurance that our integrated roofing solutions can be specified and installed with complete confidence.

- ▲ For more information visit marley.co.uk/resources



▲ Innovation in clay

Plain tiles made from clay have been used to cover roofs in Britain for over eight hundred years and they form much of the character of the roofs seen in the South East of England and the Midlands, where the largest deposits of clay are located.

Our extensive range contains colour and texture options which meet the aesthetic and performance demands of all types of roofing applications.

- ▲ BES 6001 'Excellent' rating and A+ rated in the BRE Green Guide
- ▲ Durable, natural material
- ▲ Full range of colours and finishes
- ▲ 30° low pitch options
- ▲ Full range of fittings and accessories
- ▲ Independent carbon footprint certification
- ▲ Premium range of handmade tiles

CANTERBURY

HANDMADE CLAY PLAIN TILES



Nothing compares to handmade clay plain tiles. That's why our range of Canterbury handmade roof tiles are created true to tradition.

TECHNICAL TOOLKIT

Marley provides a comprehensive technical service and a range of online tools to ensure design performance and compliance to the latest British Standards and NHBC technical guidelines. These services include:

- ▲ Fixing specifications: marley.co.uk/fixingspec
- ▲ NBS clauses: marley.co.uk/specrite
- ▲ CAD details: marley.co.uk/cad
- ▲ BIM models: marley.co.uk/bim

For more information on the recent update to the British Standard for Slating and Tiling (BS 5534) and how it might affect your project, please visit marley.co.uk/BS5534

FEATURE TILES

Available in a range of colours. For advice on the use of feature tiles in main roof areas, contact the Technical Advisory Service.

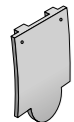

Club



Bullnose

SUSTAINABILITY

Green guide rating A+ (Element ref: 812410006)

BES 6001 Excellent— can achieve 3 credits

EPD summary GWP-total A1-A3 – 4.75 kg CO₂e

COLOUR AVAILABILITY

See page 10 for more detailed colour panel.

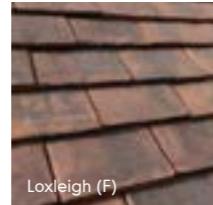

Key: (F) Fine sanded finish

TECHNICAL DATA

Size of tile	265mm x 165mm	
Minimum pitch*	40°	
Maximum pitch	90°	
Minimum headlap	65mm (roof)	35mm (vertical)
Maximum gauge	100mm (roof)	115mm (vertical)
Cover width	165mm (nominal)	
Tile thickness	13mm (nominal)	
Covering capacity (net)	60 tiles/m ² at 100mm gauge (roof) 53 tiles/m ² at 115mm gauge (vertical)	
Weight of tiling (approx.)	74kg/m ² (0.73 kN/m ²) at 100mm gauge (roof) 66kg/m ² (0.64 kN/m ²) at 115mm gauge (vertical)	
Battens required (net)	10.0 lin.m/m ² at 100mm gauge (roof) 8.7 lin.m/m ² at 115mm gauge (vertical)	
Batten size recommended	38 x 25mm for rafters/supports not exceeding 600mm centres (fixed to BS 5534)	
Tile nails	38mm x 2.65mm	
Authority	BS EN 1304	

* The minimum recommended pitch and lap may be influenced by special circumstances, please contact the Technical Advisory Service.



CANTERBURY LOXLEIGH FINE SANDED FINISH



DENHAM CASE STUDY

PROJECT INFORMATION

Location/
Denham

Application/
Residential

Product/
Canterbury Loxleigh



Canterbury handmade clay plain tiles in Loxleigh colour have been used to create an authentic roof for a new build historic-style cottage in the Denham conservation area. The self-build project, in the picturesque old English village, had to adhere to strict planning guidelines for roof height and use of materials due to the number of listed buildings along the same road.

▲ Find more case studies at [marley.co.uk/casestudies](https://www.marley.co.uk/casestudies)

ACME SINGLE CAMBER STANDARD CLAY PLAIN TILES



The Acme single camber clay plain tile allows the creation of traditional and contemporary low pitch roof designs with the warmth and character of clay.

TECHNICAL TOOLKIT

Marley provides a comprehensive technical service and a range of online tools to ensure design performance and compliance to the latest British Standards and NHBC technical guidelines. These services include:

- ▲ Fixing specifications: marley.co.uk/fixingspec
- ▲ NBS clauses: marley.co.uk/specrite
- ▲ CAD details: marley.co.uk/cad
- ▲ BIM models: marley.co.uk/bim

For more information on the recent update to the British Standard for Slating and Tiling (BS 5534) and how it might affect your project, please visit marley.co.uk/BS5534

FEATURE TILES

Available in a range of colours. For advice on the use of feature tiles in main roof areas, contact the Technical Advisory Service.

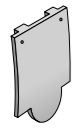

Club



Bullnose

SUSTAINABILITY

Green guide rating A+ (Element ref: 812410006)

BES 6001 Excellent – can achieve 3 credits

EPD summary GWP-total A1-A3 – 4.75 kg CO₂e

COLOUR AVAILABILITY

See pages 14-25 for more detailed colour panels.

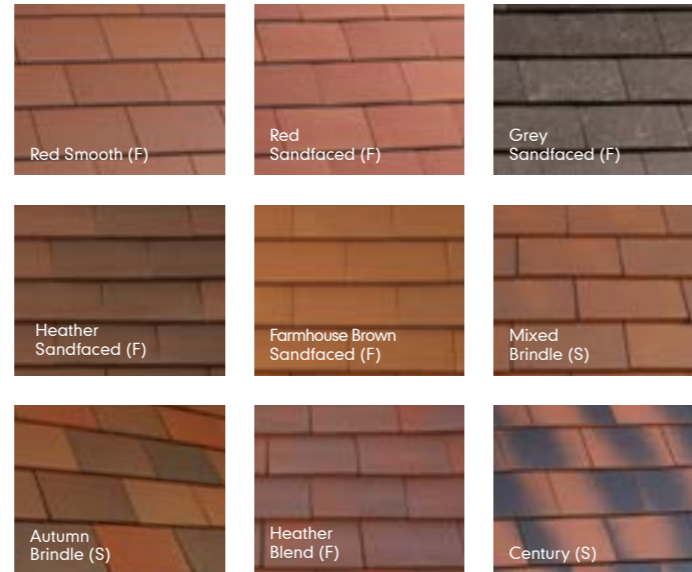

Key: (F) Fine sanded finish (S) Smooth finish

TECHNICAL DATA

Size of tile	265mm x 165mm	
Minimum pitch*	30°	
Maximum pitch	90°	
Minimum headlap	65mm (roof)	35mm (vertical)
Maximum gauge	100mm (roof)	115mm (vertical)
Cover width	165mm (nominal)	
Tile thickness	11mm (nominal)	
Covering capacity (net)	60 tiles/m ² at 100mm gauge (roof) 53 tiles/m ² at 115mm gauge (vertical)	
Weight of tiling (approx.)	64kg/m ² (0.63 kN/m ²) at 100mm gauge (roof) 56kg/m ² (0.55 kN/m ²) at 115mm gauge (vertical)	
Battens required (net)	10.0 lin.m/m ² at 100mm gauge (roof) 8.7 lin.m/m ² at 115mm gauge (vertical)	
Batten size recommended	38 x 25mm for rafters/supports not exceeding 600mm centres (fixed to BS 5534)	
Tile nails	38mm x 2.65mm	
Authority	BS EN 1304	

* The minimum recommended pitch and lap may be influenced by special circumstances, please contact the Technical Advisory Service.



Red Smooth (F)

ACME SINGLE CAMBER STANDARD
RED SMOOTH
SMOOTH FINISH



ACME SINGLE CAMBER STANDARD
RED SANDFACED
FINE SANDED FINISH



POACHER'S RETREAT CASE STUDY

PROJECT INFORMATION

Location/
South

Application/
Residential

Product/
Acme Single Camber
(Grey Sandfaced)

Specifier/
Malcolm Cox



This idyllic home set in its own country grounds needed a traditional tile with a strong performance. The Acme Single Camber Clay Tile's ability to drop to 30° minimum pitch provided great versatility for the designers and contractors to work with.

▲ Find more case studies at marley.co.uk/casestudies

ACME SINGLE CAMBER GREY SANDFACED SMOOTH FINISH



ACME SINGLE CAMBER
HEATHER SANDFACED
FINE SANDED FINISH



ACME SINGLE CAMBER
FARMHOUSE BROWN SANDFACED
FINE SANDED FINISH



ACME SINGLE CAMBER
MIXED BRINDLE
SMOOTH FINISH



BRICKYARD LANE
CASE STUDY

PROJECT INFORMATION

Location/
Midlands

Application/
Residential

Product/
Acme Single Camber
(Mixed Brindle)

Specifier/
Martin Hayward



A luxury self build project in Warwickshire has used an innovative mixed brindle clay plain tile to give the roof a traditional, high quality aesthetic, in keeping with the home's rural surroundings.

▲ Find more case studies at marley.co.uk/casestudies

ACME SINGLE CAMBER
AUTUMN BRINDLE
SMOOTH FINISH

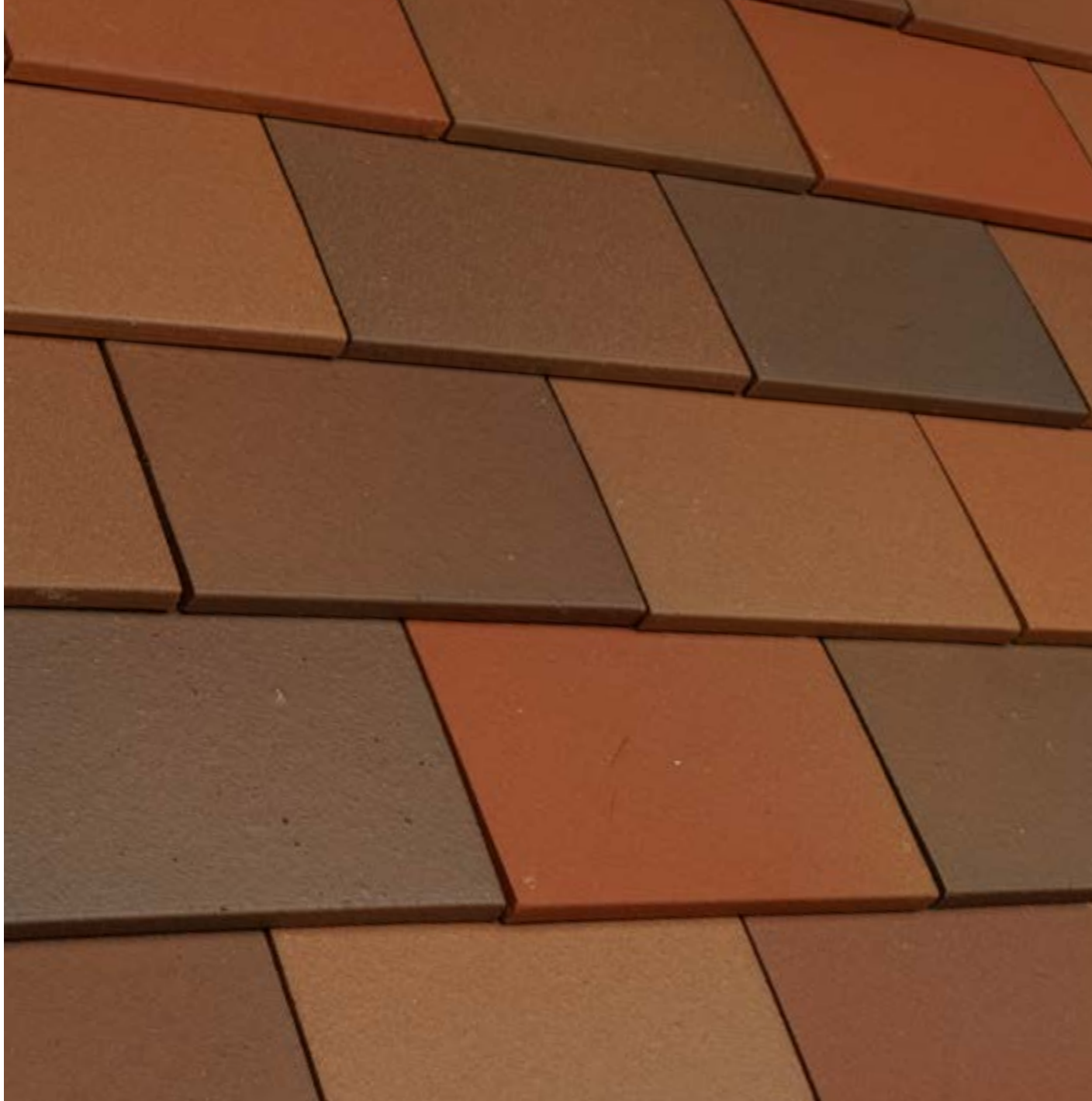

ACME SINGLE CAMBER
HEATHER BLEND
FINE SANDED FINISH



HOLIDAY INN CASE STUDY

PROJECT INFORMATION

Location/
South East England

Application/
Commercial

Product/
Acme Single Camber
(Century)

Contractor/
Imperial Roofing



152,000 Acme Single Camber clay plain tiles were used on a new Holiday Inn Hotel in Colchester. The Century colour was specified to offer a stunning mix of natural clay, complemented by the tiles darkened flashes to provide a subtle blend.

▲ Find more case studies at [marley.co.uk/casestudies](https://www.marley.co.uk/casestudies)

ACME SINGLE CAMBER CENTURY SMOOTH FINISH



ACME SINGLE CAMBER HERITAGE CLAY PLAIN TILES



The Acme single camber clay plain tile allows the creation of traditional and contemporary low pitch roof designs with the warmth and character of clay.

TECHNICAL TOOLKIT

Marley provides a comprehensive technical service and a range of online tools to ensure design performance and compliance to the latest British Standards and NHBC technical guidelines. These services include:

- ▲ Fixing specifications: marley.co.uk/fixingspec
- ▲ NBS clauses: marley.co.uk/specrite
- ▲ CAD details: marley.co.uk/cad
- ▲ BIM models: marley.co.uk/bim

For more information on the recent update to the British Standard for Slating and Tiling (BS 5534) and how it might affect your project, please visit marley.co.uk/BS5534

FEATURE TILES

Available in a range of colours. For advice on the use of feature tiles in main roof areas, contact the Technical Advisory Service.

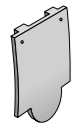

Club



Bullnose

SUSTAINABILITY

Green guide rating A+ (Element ref: 812410006)

BES 6001 Excellent – can achieve 3 credits

EPD summary GWP-total A1-A3 – 4.75 kg CO₂e

COLOUR AVAILABILITY

See pages 28-29 for more detailed colour panels.

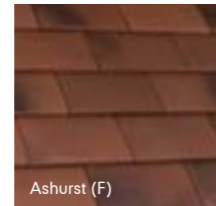

Ashurst (F)

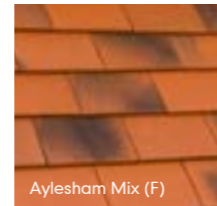

Aylesham Mix (F)

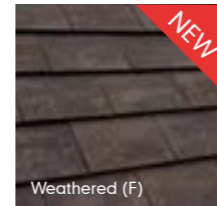

Weathered (F)

Key: (F) Fine sanded finish

TECHNICAL DATA

Size of tile	265mm x 165mm	
Minimum pitch*	30°	
Maximum pitch	90°	
Minimum headlap	65mm (roof)	35mm (vertical)
Maximum gauge	100mm (roof)	115mm (vertical)
Cover width	165mm (nominal)	
Tile thickness	11mm (nominal)	
Covering capacity (net)	60 tiles/m ² at 100mm gauge (roof) 53 tiles/m ² at 115mm gauge (vertical)	
Weight of tiling (approx.)	64kg/m ² (0.63 kN/m ²) at 100mm gauge (roof) 56kg/m ² (0.55 kN/m ²) at 115mm gauge (vertical)	
Battens required (net)	10.0 lin.m/m ² at 100mm gauge (roof) 8.7 lin.m/m ² at 115mm gauge (vertical)	
Batten size recommended	38 x 25mm for rafters/supports not exceeding 600mm centres (fixed to BS 5534)	
Tile nails	38mm x 2.65mm	
Authority	BS EN 1304	

* The minimum recommended pitch and lap may be influenced by special circumstances, please contact the Technical Advisory Service.



ACME SINGLE CAMBER HERITAGE
ASHURST
FINE SANDED FINISH

AYLESHAM MIX
FINE SANDED FINISH

ACME SINGLE CAMBER HERITAGE
WEATHERED
FINE SANDED FINISH



HAWKINS

MACHINE-MADE CLAY PLAIN TILES



The name 'Hawkins' has been synonymous with quality roofs for over 150 years. This heritage, combined with our modern firing techniques, gives a unique colour range.

TECHNICAL TOOLKIT

provides a comprehensive technical service and a range of online tools to ensure design performance and compliance to the latest British Standards and NHBC technical guidelines. These services include:

- ▲ Fixing specifications: marley.co.uk/fixingspec
- ▲ NBS clauses: marley.co.uk/specrite
- ▲ CAD details: marley.co.uk/cad
- ▲ BIM models: marley.co.uk/bim

For more information on the recent update to the British Standard for Slating and Tiling (BS 5534) and how it might affect your project, please visit marley.co.uk/BS5534

FEATURE TILES

Available in a range of colours. For advice on the use of feature tiles in main roof areas, contact the Technical Advisory Service.

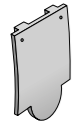

Club



Bullnose

SUSTAINABILITY

Green guide rating A+ (Element ref: 812410006)

BES 6001 Excellent – can achieve 3 credits

EPD summary GWP-total A1-A3 – 4.75 kg CO₂e

COLOUR AVAILABILITY

See pages 32-37 for more detailed colour panels.

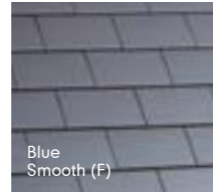

Blue Smooth (F)

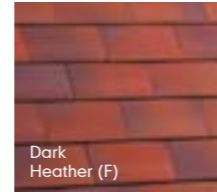

Dark Heather (F)

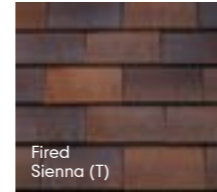

Fired Sienna (T)



Staffordshire Mix (F)

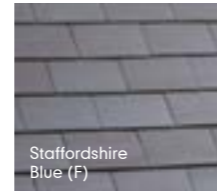

Staffordshire Blue (F)

Key: (F) Fine sanded finish (S) Smooth finish (T) Textured finish

TECHNICAL DATA

Size of tile	265mm x 165mm	
Minimum pitch*	30°	
Maximum pitch	90°	
Minimum headlap	65mm (roof)	35mm (vertical)
Maximum gauge	100mm (roof)	115mm (vertical)
Cover width	165mm (nominal)	
Tile thickness	11mm (nominal)	
Covering capacity (net)	60 tiles/m ² at 100mm gauge (roof) 53 tiles/m ² at 115mm gauge (vertical)	
Weight of tiling (approx.)	64kg/m ² (0.63 kN/m ²) at 100mm gauge (roof) 56kg/m ² (0.55 kN/m ²) at 115mm gauge (vertical)	
Battens required (net)	10.0 lin.m/m ² at 100mm gauge (roof) 8.7 lin.m/m ² at 115mm gauge (vertical)	
Batten size recommended	38 x 25mm for rafters/supports not exceeding 600mm centres (fixed to BS 5534)	
Tile nails	38mm x 2.65mm	
Authority	BS EN 1304	

* The minimum recommended pitch and lap may be influenced by special circumstances, please contact the Technical Advisory Service.



Dark Heather (F)

HAWKINS BLUE SMOOTH
SMOOTH FINISH



HAWKINS DARK HEATHER
FINE SANDED FINISH



MALVERN CHURCH CASE STUDY

PROJECT INFORMATION

Location/
Midlands

Application/
Refurbishment

Product/
Hawkins Fired Sienna

Specifier/
Nick Joyce Architects



The unique weathered texture was the deciding factor in the specification of Fired Sienna for this renovation. Following a successful restoration appeal, the Baptist Church wanted a reclaimed look about the finished roof whilst ensuring it would last for years to come.

▲ Find more case studies at [marley.co.uk/casestudies](https://www.marley.co.uk/casestudies)

HAWKINS FIRED SIENNA TEXTURED FINISH



HAWKINS STAFFORDSHIRE MIX
SMOOTH FINISH



HAWKINS STAFFORDSHIRE BLUE
FINE SANDED FINISH



DETAILING CLAY PLAIN TILE ROOF SYSTEMS

▲ We at Marley design our roofing products as holistic systems. Our dry fix and ventilation solutions are a key part of our roof system, enabling flexibility in design and detailing; offering weatherproofing, security and refined aesthetics, as well as providing excellent levels of ventilation.

They are also quick, straightforward and economical to install, and for the building owner, they require minimal ongoing maintenance but give maximum durability and long life.

MARLEY DRY FIX SYSTEMS

To improve the speed and economy of roof construction, a choice of high performance, maintenance-free dry fix systems are offered to suit ridge, verge, hip and valley details providing easy to fix alternatives to traditional mortar bedding. When correctly installed, they are designed to satisfy the requirements of BS 5534 'Code of practice for slating and tiling' with respect to the mechanical fixing of roof fittings to resist wind uplift and the provision of a weathertight roof.

Available systems: Universal RidgeFast, Universal HipFast, Dry Hip system, Dry ridge and mono ridge, Universal plain tile dry verge system, Cloak verge tiles, Universal GRP Dry valley, Bonding gutters.

MARLEY VENTILATION SYSTEMS

To assist the designer in meeting the requirements of the Building Regulations, Marley has developed a range of ventilation accessories that combine discreet and aesthetic solutions with the highly efficient removal of moisture-laden air and gases. This comprehensive range is designed to ventilate roof voids with terminals for the ridge and roof, with connection to mechanical extract systems and soil vent pipes, allowing easy provision of precise amounts of free airspace.

Available systems: Universal eaves ventilation systems (10 and 25mm), Universal RidgeFast, Universal HipFast, Ventilated dry ridge and mono ridge, Ridge vent terminals, In-line vents.

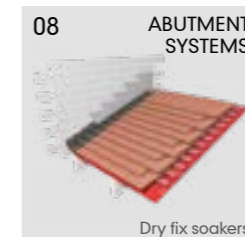
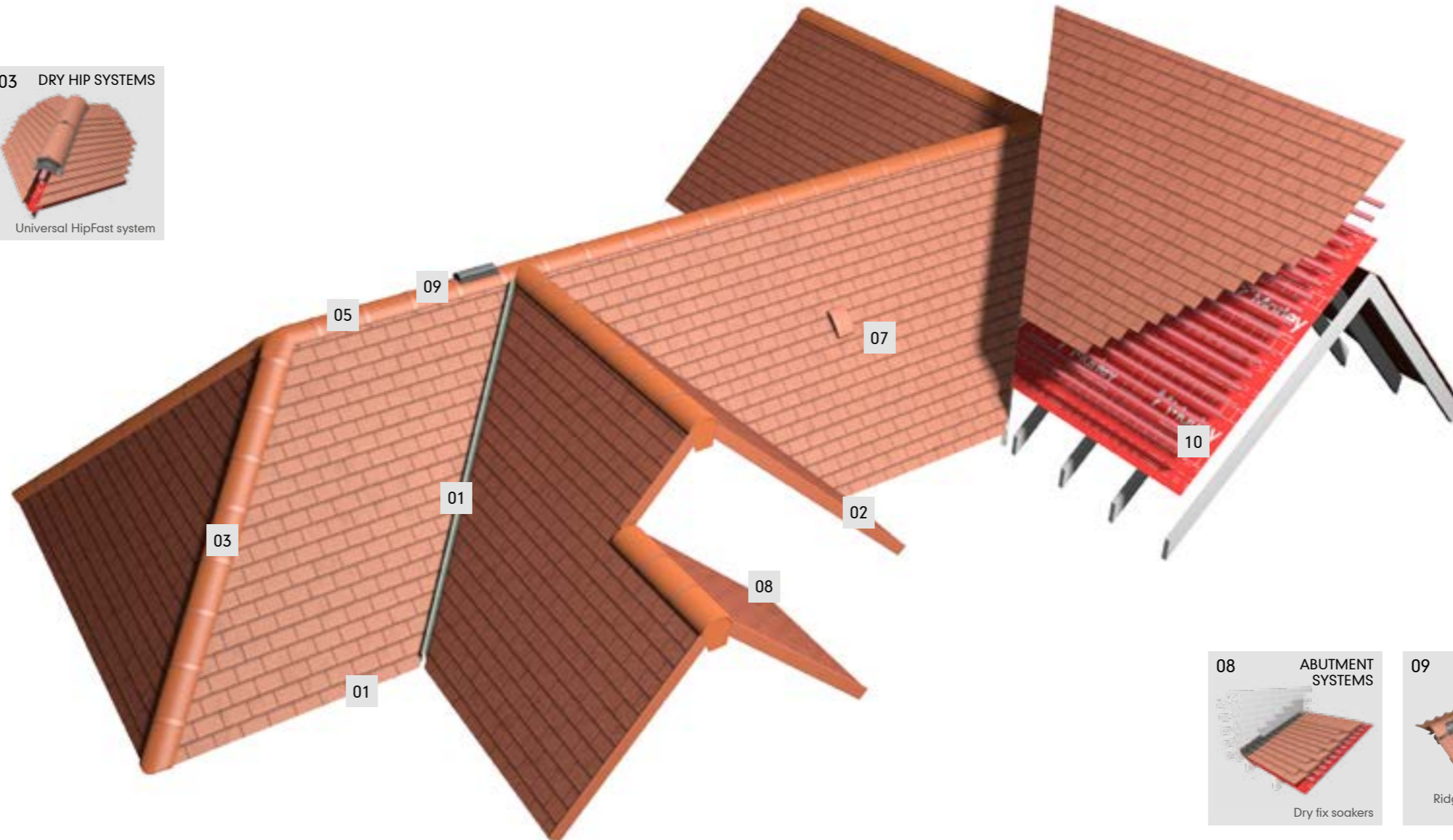
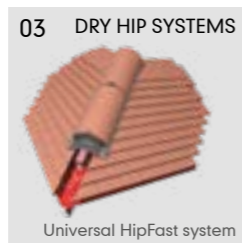
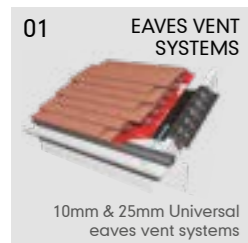

BASE LAYERS UNDERLAYS & BATTENS FOR ROOF SYSTEMS

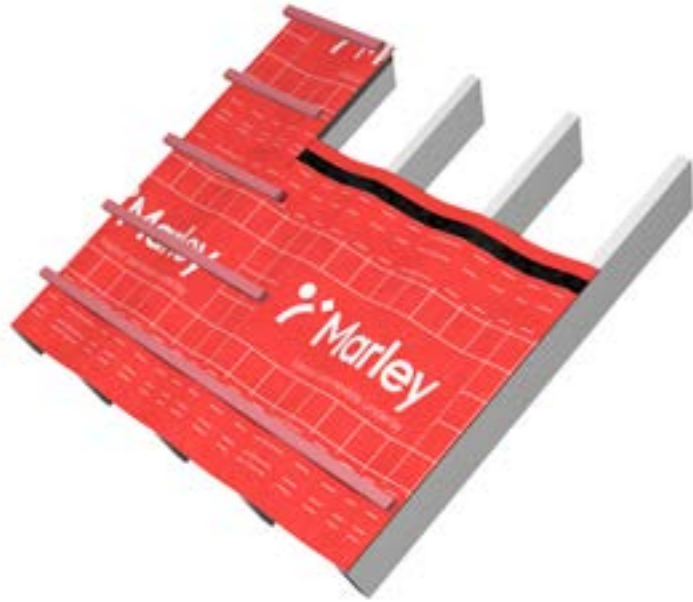

UNIVERSAL VAPOUR PERMEABLE UNDERLAY

Universal vapour permeable underlay is a lightweight, high performance breathable membrane for pitched roofs. Supplied in 1m x 50m rolls with integrated tape for sealing laps, the underlay is fully compliant to BS 5534 and suitable for all UK wind zones 1-5.

Universal vapour permeable underlay is designed to integrate seamlessly within a full Marley roof system and provides an additional means of ventilation to meet the requirements of BS 5250*.

* Consideration must be given to the type of roof covering used, which will influence the ventilation requirements. For further info, please contact the Marley technical department.

BENEFITS

- ▲ Vapour permeable
- ▲ High tensile and tear strength
- ▲ Clean and easy to handle
- ▲ Durable
- ▲ UV resistant
- ▲ BBA approved – Certificate No. 16/5335
- ▲ Integrated tape for sealing laps
- ▲ Guidance lines for minimum laps
- ▲ Suitable for vertical applications

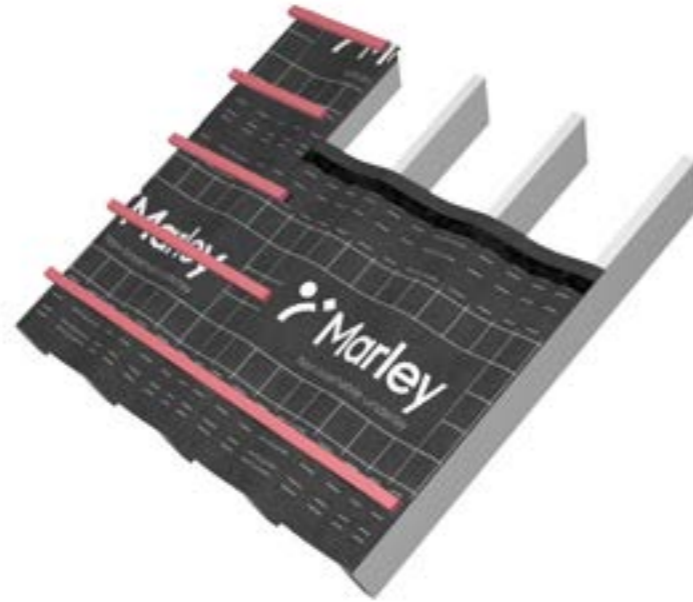

UNIVERSAL NON-PERMEABLE UNDERLAY

Universal non-permeable underlay is a lightweight, high performance membrane for pitched roofs. Supplied in 1m x 45m rolls with integrated tape for sealing laps, the underlay is fully compliant to BS 5534 and suitable for all UK wind zones 1-5.

Universal non-breathable underlay is designed to integrate seamlessly within a full Marley roof system and is suitable for roofs with traditional ventilation products or ventilated batten cavities.

BENEFITS

- ▲ Non-breathable
- ▲ High tensile and tear strength
- ▲ Clean and easy to handle
- ▲ Durable
- ▲ UV resistant
- ▲ BBA approved – Certificate No. 16/5334
- ▲ Lightweight alternative to traditional IF
- ▲ Integrated tape for sealing laps
- ▲ Guidance lines for minimum laps

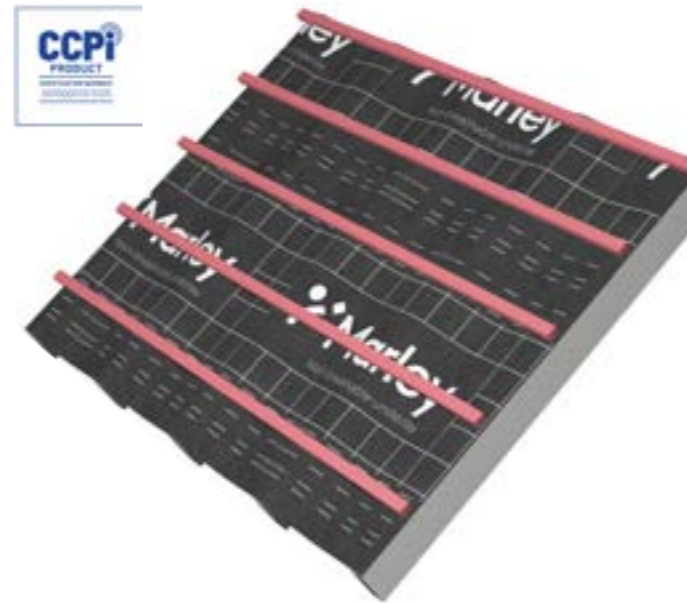

JB RED

JB Red completely meets the BS 5534 and NHBC requirements for fully graded roofing battens and it is the only UK factory graded roof batten certified by the BBA (Certificate 19/5668). The battens are exceptionally strong and have full chain of custody certification and JB Red was the first roofing batten to achieve CCPI verification.

Its distinctive red colour means that it is highly visible on site, therefore Local Authority Building Control, NHBC and other inspectors can see that high quality, pre-graded and compliant battens have been used.

JB Red is manufactured using a state of the art, high speed camera and laser grading machine to ensure consistent levels of size and quality.

JB Red is Kopper's MicroPro® treated and carries a 60 year life expectancy against attack by wood rotting fungi and insects.

BENEFITS OF JB RED

- ▲ Pre-graded to all the size and strength requirements of BS 5534 for roofing battens. No further grading is required
- ▲ Manufactured from slow grown, high grade timber and marked according to BS 5534 showing supplier name, origin/species, grade and size



- ▲ Only kiln dried sideboard timber is used to ensure stability and dimensional accuracy
- ▲ Reduced wastage through state of the art mechanical grading
- ▲ JB Red is LABC registered and is approved for use by local authorities
- ▲ The product and process are UKAS third party assessed by the BBA with a BBA Agrément certificate (19/5668)
- ▲ JB Red is CCPI verified (001500013/1025)
- ▲ Treated to BS 8417 Usage Class 2, using Koppers MicroPro® with a unique red colour
- ▲ 60 year life expectancy against insect attack and wood rotting fungi (when installed correctly in accordance with the requirements of Usage Class 2)

BATTEN END CLIPS

These are for use with all dry verge units. Easily fitted to the batten end, they provide easy, fast and positive fixing of dry verge units to the batten end. Compliant with BS 8612.

FITTINGS & ACCESSORIES FOR CLAY PLAIN TILES

Marley manufacture a wide range of clay plain tile fittings, decorative ridges and finials. All products can be installed in line with the latest BS 5534 'Code of Practice for Slating and Tiling' and NHBC Technical Standards.

Important note: All the fittings shown on these pages can be used with clay plain tiles.

PLAIN TILE FITTINGS

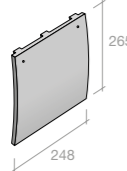
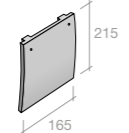
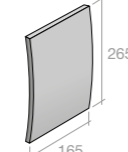
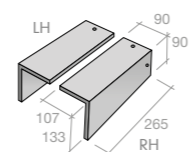
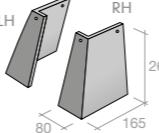
					
Description	Tile-and-a-half	Eaves/top tile	Creasing tiles§	Cloaked verge tiles*	external angle tiles
Angles available	n/a	n/a	n/a	n/a	90°, 135°

RIDGE TILES

Mortar bedded security ridge kits are available (see page 43)

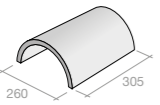
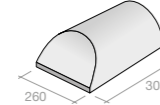
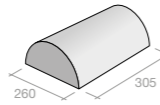
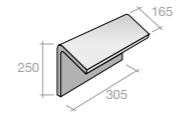
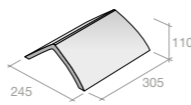
					
Description	Half round ridge	Half round ridge hip end*	Half round ridge stop end*	Mono ridge*	Hogs back ridge**
Angles available	n/a	n/a	130°, 135°, 145°	130°, 135°, 140°, 145°, 150°	n/a
Colours available	All colours	All colours	All colours	All colours	All colours
Pitch range‡	30-50°	30-50°	30-50°	30-45°	30-45°

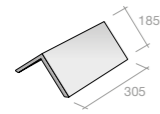
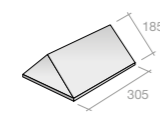
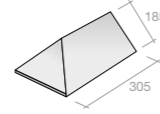
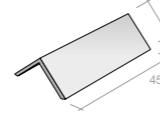
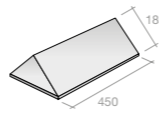
					
Description	305mm Angular ridge**	305mm Angular ridge stop end*	305mm Angular ridge hip end*	450mm Angular ridge	450mm Angular ridge stop end*
Angles available	90°, 105°	90°, 105°	90°, 105°	75°, 90°, 105°, 115°, 125°, 135°	75°, 90°, 105°, 115°, 125°, 135°
Colours available	All colours	All colours	All colours	Red Smooth, Slate Black	Red Smooth, Slate Black
Pitch range‡	See Tables 1, 3, 4, 5 & 6	See Tables 1, 3, 4, 5 & 6	See Tables 1, 3, 4, 5 & 6	See Tables 1, 3, 4, 5 & 6	See Tables 1, 3, 4, 5 & 6

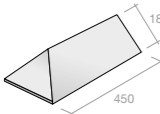
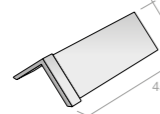
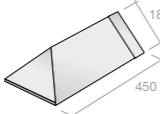
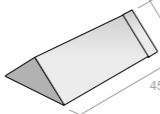
				
Description	450mm Angular ridge hip end*	450mm Capped angular ridge	450mm Capped angular ridge hip end	450mm Capped angular ridge stop end
Angles available	75°, 90°, 105°, 115°, 125°, 135°	75°, 90°, 105°, 115°, 125°, 135°	75°, 90°, 105°, 115°, 125°, 135°	75°, 90°, 105°, 115°, 125°, 135°
Colours available	Red Smooth, Slate Black	Red Smooth, Slate Black, Staffordshire Blue***	Red Smooth, Slate Black, Staffordshire Blue***	Red Smooth, Slate Black, Staffordshire Blue***
Pitch range‡	See Tables 1, 3, 4, 5 & 6	See Tables 1, 3, 4, 5 & 6	See Tables 1, 3, 4, 5 & 6	See Tables 1, 3, 4, 5 & 6

FEATURE TILES

Available in a range of colours, please contact customer services for more information.

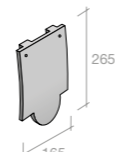
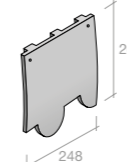
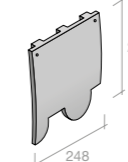
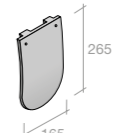
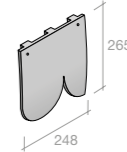
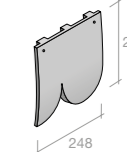
						
Description	Club feature tile*	RH club tile-and-a-half*	LH club tile-and-a-half*	Bullnose feature tile*	RH bullnose tile-and-a-half*	LH bullnose tile-and-a-half*

HIPS AND VALLEYS

Mortar bedded security hip kits are available for third round ridges (see page 43)

						
Description	Granny hip	Semi bonnet hip	Arris hip**	Valley**	Third round hip**	Third round hip end**
Angles available	n/a	n/a	130°, 135°, 145°	130°, 135°, 140°, 145°, 150°	n/a	n/a
Pitch range‡	40-60°	30-40°	30-45°	30-50°	30-45°	30-45°

TABLE 1

Relationship of roof pitch to internal angle of hip

Known roof pitch	internal angles of hip tile	
	Plain tile roof	Slate roof
20-25°	-	135°
30°	145°	135°
35°	145°	125°
37.5°	140°	125°
40°	135°	115°
42.5°	135°	115°
45°	130°	115°
47.5°	127°	115°
50°	125°	105°
52.5°	120°	-
55°	120°	-
57.5°	115°	-
60°	115°	-

TABLE 2

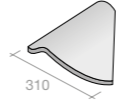
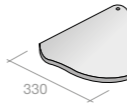
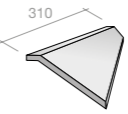
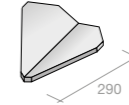
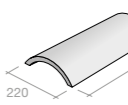
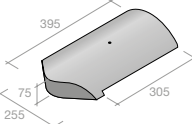
Relationship of roof pitch to valley angle

Known roof pitch	internal angles of hip tile	
	Plain tile roof	
30°	150°	
35°	150°	
37.5°	145°	
40°	140°	
42.5°	140°	
45°	135°	
50°	130°	

TABLE 3

Relationship of plain tile roof pitch to internal angle of ridge tiles

Known roof pitch	internal angles of ridge tile	
	Plain tile roof	
30°	115°	
35°	105°	
37.5°	105°	
40°	105°	
42.5°	90°	
45°	90°	
47.5°	90°	
50°	90°	
52.5°	-	
55°	75°	
57.5°	75°	
60°	75°	

TABLE 4

Relationship of slate roof pitch to internal angle of ridge tiles

Known roof pitch	internal angles of ridge tile	
	Slate roof	
20-25°	125°	
30°	115°	
35°	105°	
37.5°	90°	
40°	90°	
42.5°	75°	
45°	75°	
47.5°	75°	
50°	75°	

TABLE 5

Relationship of internal angle of ridge tiles to roof (plain tiles)

Known internal angle of ridge tile	Plain tile roof pitch
75°	52.5-60°
90°	42.5-52.5°
105°	30-42.5°

TABLE 6

Relationship of internal angle of ridge tiles to roof (slates)

Known internal angle of ridge tile	Slate roof pitch
75°	45-50°
90°	35-45°
105°	35°
115°	30°
125°	20-30°

* Made to order (subject to minimum order quantities)

** Some colours and angles made to order (subject to minimum order quantities)

*** Staffordshire Blue available to order

† Angle ridge wing length will vary depending on ridge angle

§ Available in Red Smooth

‡ Guidance only. Range is variable depending on the combined ridge system, roof tile and pitch. For further information, please contact our technical advisory service on 01283 722330

FITTINGS & ACCESSORIES FOR CLAY PLAIN TILES

Marley manufacture a wide range of clay plain tile fittings, decorative ridges and finials. All products can be installed in line with the latest BS 5534 'Code of Practice for Slating and Tiling' and NHBC Technical Standards.

Important note: All the fittings shown on these pages can be used with clay plain tiles.

DECORATIVE RIDGES

Mortar bedded security ridge kits are available (see page 43)



Description	Plain roll top**	Club crested ridge	Cocks comb crested ridge	Two hole crested ridge
Angles available	75°, 90°, 105°, 115°, 125°, 135°	90°, 105°	90°, 105°	90°, 105°
Colours available	Red Smooth, Slate Black	Red Smooth	Red Smooth	Red Smooth
Pitch range‡	See Tables 1, 3, 4, 5 & 6 (page 57)	See Tables 1, 3, 4, 5 & 6 (page 57)	See Tables 1, 3, 4, 5 & 6 (page 57)	See Tables 1, 3, 4, 5 & 6 (page 57)

RIDGE TILES

Mortar bedded security ridge kits are available (see page 43)

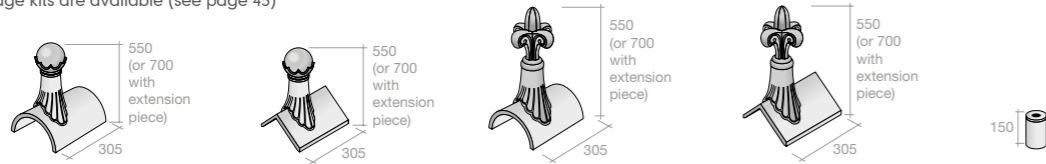

Description	Ball top finial* (half round base)	Ball top finial* (plain angle base)	Fleur-de-Lys gable* (half round base)	Fleur-de-Lys gable* (plain angle base)	Extension piece (for Ball top / Fleur-de-Lys)
Angles available	n/a	75°, 90°, 105°, 115°, 125°, 135°	n/a	75°, 90°, 105°, 115°, 125°, 135°	n/a
Colours available	All colours	Red Smooth, Slate Black (all angles) Other colours (90°, 105° angles only)	All colours	Red Smooth, Slate Black (all angles) Other colours (90°, 105° angles only)	All colours
Pitch range‡	30-50°	See Tables 1, 3, 4, 5 & 6 (page 57)	30-50°	See Tables 1, 3, 4, 5 & 6 (page 57)	n/a

* Made to order (subject to minimum order quantities)

** Some colours and angles made to order (subject to minimum order quantities)

† Angle ridge wing length will vary depending on ridge angle

‡ Guidance only. Range is variable depending on the combined ridge system, roof tile and pitch. For further information, please contact our technical advisory service on 01283 722330

SERVICES

Marley offer a full range of technical and online advice services, including NBS and fixing specifications, which will help you meet the requirements of BS 5534.

▲ Fixing specifications marley.co.uk/fixingspec ▲ NBS clauses marley.co.uk/specrite

MORTAR BEDDED SECURITY FIXING

Under BS 5534, the use of mortar as a sole means of fixing roof tiles and fittings is insufficient. Not only should careful consideration be given to the creation of a suitable roof mortar through the correct sand and cement mix, but tiles or fittings bedded with this mortar must also be accompanied by a mechanical fix.



MORTAR BEDDED SECURITY HIP

Mechanical fixing system for mortar bedded ridge hip, helping house builders and contractors meet British Standards and NHBC guidelines.

Watch a quick video on mortar bedded mechanical fixing at marley.co.uk/securityhip or scan the QR code shown

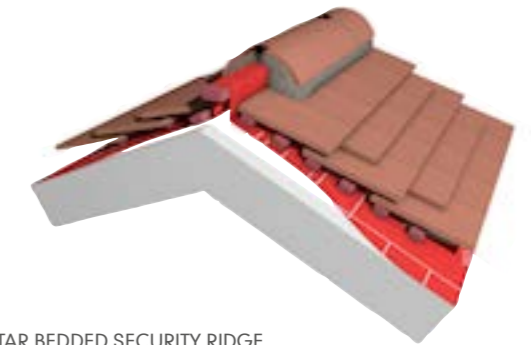

MORTAR BEDDED SECURITY RIDGE

Mechanical fixing system for mortar bedded ridge ridges, helping house builders and contractors meet British Standards and NHBC guidelines.

Watch a quick video on mortar bedded mechanical fixing at marley.co.uk/securityridge or scan the QR code shown

DRY FIX SOLUTIONS

Avoiding mortar with its associated risks and maintenance will always be best practice, and the changes to BS 5534 should assist in the continued adoption of dry fix.

For a mortar and maintenance free mechanical fix, Marley also offers a range of high performance dry fix solutions, including ridge and hip systems that are able to contribute towards ventilation to meet the requirements of BS 5250.



MORE ABOUT OUR DRY FIX SYSTEMS

Our website contains further information about dry fix and ventilation solutions, including the Universal range, which not only works with our roof tiles but those of other manufacturers too: www.marley.co.uk/dryfix

PROPERTIES & PERFORMANCE

ANATOMY OF SINGLE CAMBER CLAY PLAIN TILE

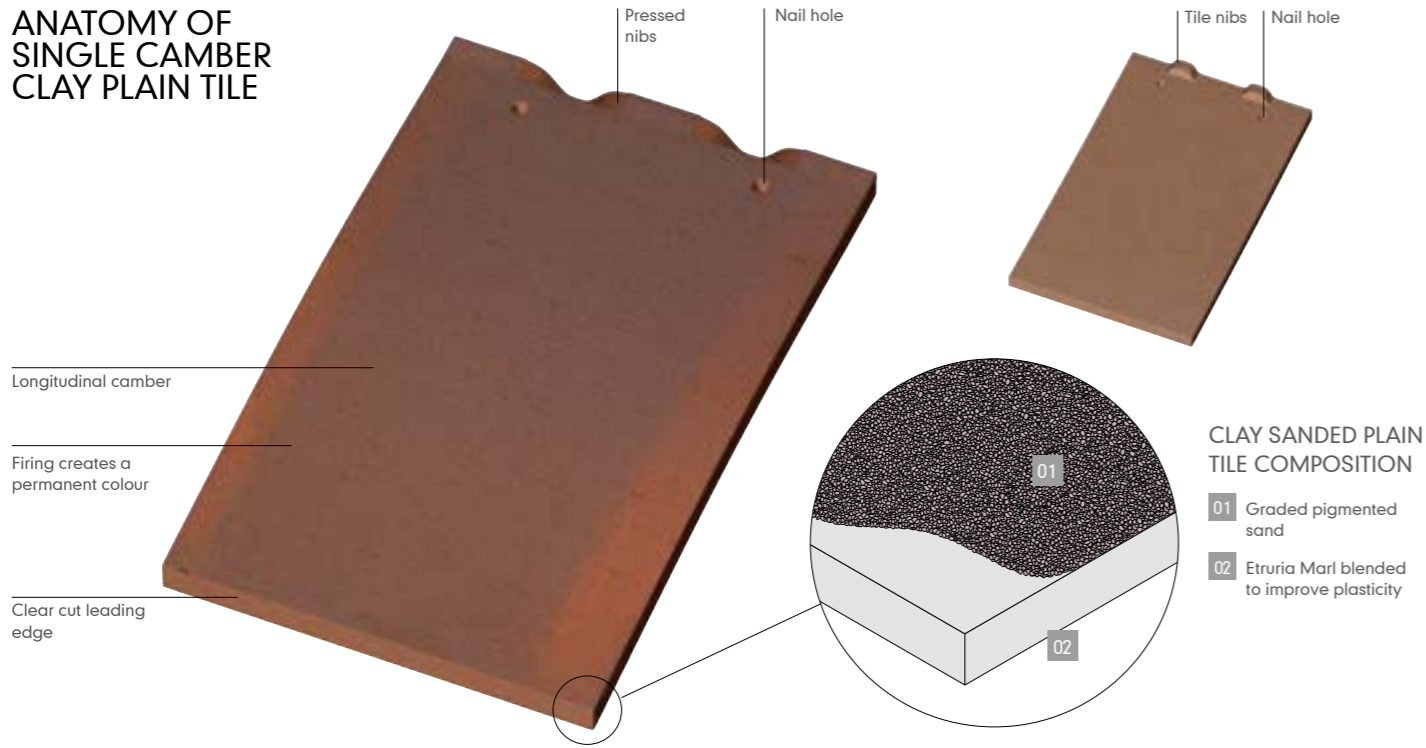

FEATURES OF CLAY PLAIN TILES

- ▲ Low pitch options down to 30°
- ▲ BES 6001 Certified 'Excellent'
- ▲ Can achieve A+ in the BRE Green Guide
- ▲ Suitable for roofing or vertical tiling
- ▲ 100% recyclable
- ▲ EPD available

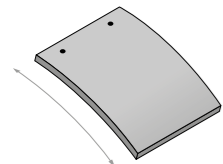

Single camber
(Acme Single Camber,
Hawkins)

AUTHORITY

Marley clay roof tiles are manufactured to BS EN 1304 'Clay roofing tiles for discontinuous laying – Product definitions and specifications', operating a quality management system meeting the requirements of BS EN ISO 9001 'Quality Management Systems – requirements'.

Additionally, the manufacturing plant operates an environmental management system, in line with BS EN ISO 14001 'Environmental management systems – Specification with guidance for use' and Health and Safety Standard OHSAS 18001.

Marley clay plain tiles are CE marked in line with the Construction Product Regulation (marley.co.uk/ce). They are also rated 'Excellent' in the BES 6001 Framework Standard for the Responsible Sourcing of Construction Products.

ENVIRONMENTAL PRODUCT DECLARATION

To see our EPD for our clay tile range go to marley.co.uk/epd

RECYCLABILITY

At end of life, clay plain tiles can be reused or crushed and used as aggregate without the need for further processing. As a natural product, no special disposal considerations are required.

COMPOSITION AND MANUFACTURE

All Marley clay plain tiles are manufactured from high quality Staffordshire Etruria Marl, generally accepted as the finest clay for strength and durability.

Clays are carefully blended to improve plasticity and strength. The tiles are machine or hand moulded, dried and fired in gas fired tunnel kilns, using an advanced computer controlled system. This ensures that the products are made to exact tolerances in shape, size, colour and strength.

PERFORMANCE

Marley clay plain tiles are tested for resistance to wind driven rain and meet the requirements of BS 5534 'Code of practice for slating and tiling (including shingles)' with respect to wind loading, when fixed in accordance with our recommendations.

STRENGTH AND DURABILITY

Marley clay plain tiles are also extremely strong, with a transverse strength well in excess of the 600N minimum requirement in BS EN 1304.

FIRE RESISTANCE

Marley clay plain tiles are non-combustible and meet the requirements for external fire performance without the need for further testing in accordance with Class B roof of BS EN 13501-5 using data from external exposure to fire roof tests (BS 476-3) as defined in ENV 1187. There are no restrictions on their use under the Building Regulations and are designated AA in Table A5 of Appendix A, Approved Document B, 'Fire Safety'.

ENVIRONMENTAL EFFECTS

THERMAL

Unaffected by extremes of temperature. Tiles should be laid with a slight gap (1-3mm) to accommodate any movement induced by changes in temperature.

The thermal resistance (R) of Marley clay tiles when dry is 0.013m²K/W.

For the purpose of thermal transmittance calculations, the preceding 'R' values should be substituted by a figure of 0.12m²K/W which includes the roof covering and the airspace behind the tiles or slates. An 'R' value of 0.020m²K/W should be added for the roof underlay.

FROST

Unaffected by frost, and meets the requirements of BS EN 1304 Annex A when tested to EN 539-2 in accordance with national requirements.

SUNLIGHT

Clay tiles do not fade and are unaffected by prolonged exposure to UV and sunlight.

ATMOSPHERIC POLLUTION

Suitable for all rural, marine and normal industrial environments. Avoid discharge of gases or liquids from chemical processes onto the surface of the tiles. Resistant to all but the most highly polluted atmospheres, where sulphur dioxide levels exceed 70 micrograms/m³ of air.

ELECTRICITY

Marley clay tiles are electronically insulating. Reference should be made to BS 6651 for recommendations on the protection of buildings against lightning strikes.

BIOLOGICAL EFFECTS

BIRDS AND RODENTS

Not affected or degraded by birds, rodents or insects.

MOSSES AND LICHENS

Water absorption of Marley clay plain tiles is very low, making their surface less likely to support growth of mosses and lichens, unless promoted by local environmental factors such as overhanging trees. Removal may only be required if growth is sufficient to restrict the drainage of water from the roof.

HEALTH AND SAFETY

When cutting tiles using an angle grinder, measures to reduce the effect of dust should be taken in accordance with the HSE Guidance Note EH 40 'Occupational Exposure Limits', EH 44 'Dust in the workplace: general principles of protection' and HSE Guidance Note EH59/2 (Respiratory Crystalline Silica). For a copy of the Marley clay tiles COSHH datasheet, visit marley.co.uk/about/HealthandSafety

APPEARANCE

To avoid the risk of colour patching and bands of different shades, tiles should be randomly selected from at least three separate pallets from the same production batch. Ensure there are sufficient quantities of mixed tiles to complete each roof elevation.

FIXING SPECIFICATION

Tiles should be fixed in accordance with the recommendations of BS 5534. The Marley Technical Advisory Service can provide a fixing specification applicable for every roof design, given the relevant criteria relating to type of roof tile, site location, topography, and building/roof dimensions. Fixing specifications can also be completed online at marley.co.uk/fixingspec

DESIGN DETAILS

EAVES

UNIVERSAL EAVES VENT SYSTEM

- ▲ eaves ventilation to satisfy 10mm or 25mm conditions
- ▲ continuous rafter roll compresses insulation to allow free air passage (use two rolls to compress deep insulation)
- ▲ strip ventilator has discreet ventilation grille and is nailed to fascia or timber fillet
- ▲ suitable with or without soffit board
- ▲ mechanically fix all tiles at eaves

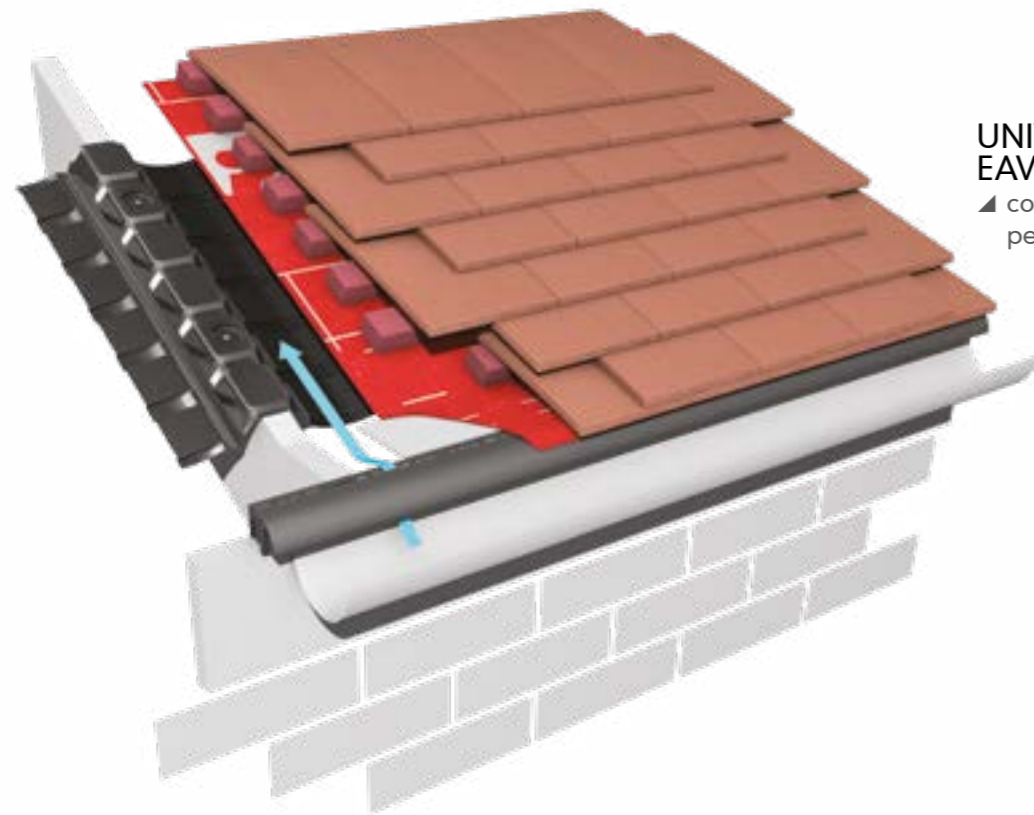
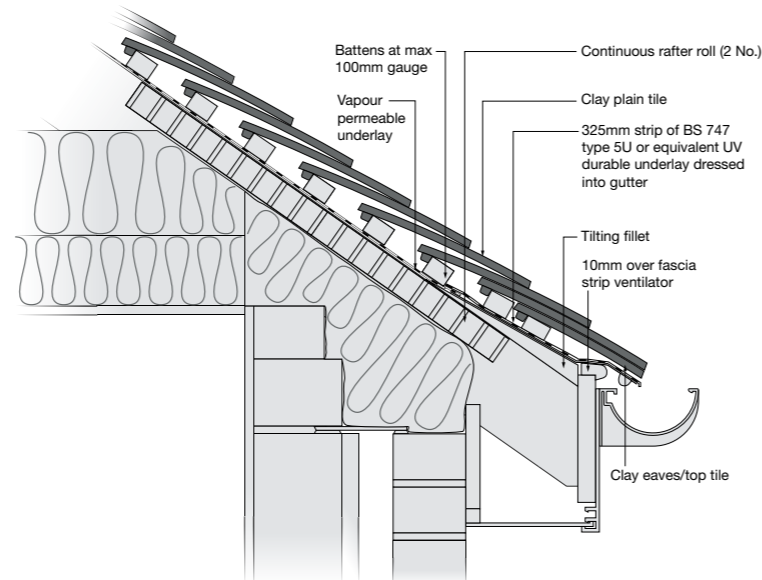

UNIVERSAL 10MM EAVES VENTILATION

- ▲ cold roof with vapour permeable underlay shown

DESIGN DETAILS

VERGES

PLAIN TILE CLOAK VERGE

- ▲ maximum pitch for duo-pitch and mono-pitch roofs is 55° (mitre top cloak verge tiles if required)
- ▲ not suitable for raking verges
- ▲ finish tiling battens flush with edge of bargeboard or brickwork
- ▲ complete verge using cloaked verge tiles
- ▲ fix all tiles with 2 No. 38mm x 2.65mm aluminium nails
- ▲ at apex of roof/verge fit block end ridge tile

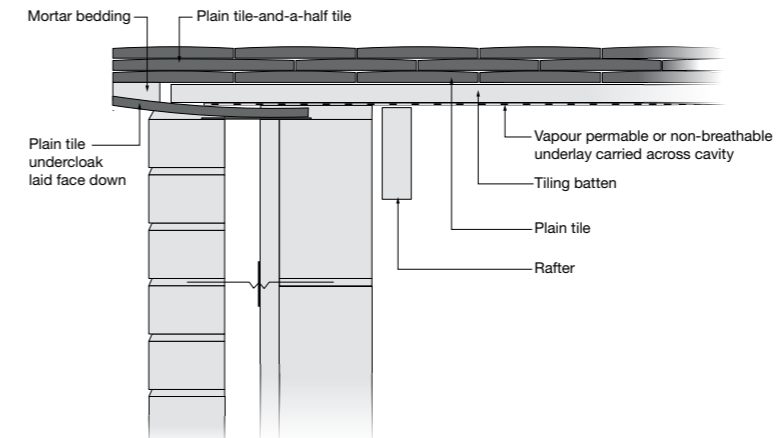

BEDDED VERGE

- ▲ form using tile and tile-and-a-half tiles in alternate courses
- ▲ use undercloak of either fibre cement laid with slope away from outer wall or plain tiles laid face down and overhanging wall
- ▲ verge overhang to be 38mm-50mm
- ▲ fully nail all tiles at verge where possible
- ▲ mortar bedding to comply with tensile board strength in BS 5534

TECHNICAL TOOLKIT

Marley provides a comprehensive technical service and a range of online tools to ensure design performance and compliance to the latest Building Regulations and NHBC Technical Standards. These services include:

- ▲ Fixing specifications marley.co.uk/fixingspec
- ▲ NBS clauses marley.co.uk/specrite
- ▲ CAD details marley.co.uk/cad
- ▲ BIM models marley.co.uk/bim

DESIGN DETAILS

HIPS

ARRIS HIP

- ▲ maximum rafter pitch 45°
- ▲ use on hips with plan angle of 90° and equal pitches on adjacent roof slopes
- ▲ fix to hip batten using 65mm x 3.35mm aluminium nail
- ▲ bed top of tiles with 3:1 sand/cement mortar to BS 5534
- ▲ complete hip at ridge or top abutment with lead saddle

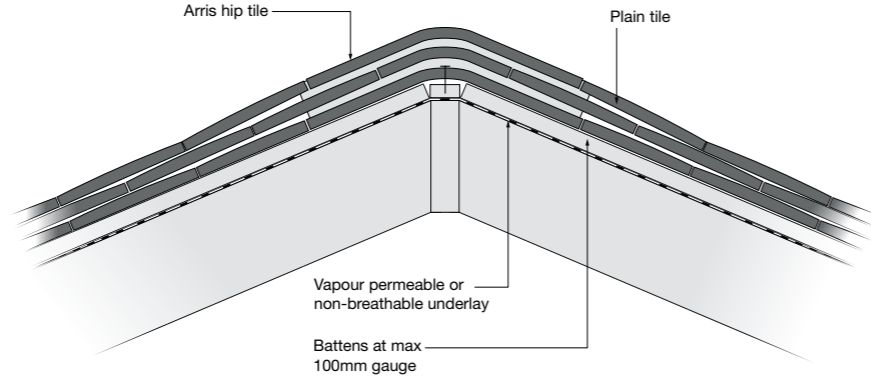

GRANNY BONNET HIP

- ▲ maximum rafter pitch 60°
- ▲ use on hips with plan angle of 90° and equal pitches on adjacent roof slopes
- ▲ fix to hip batten using 70mm x 3.35mm aluminium nail
- ▲ bed and point with 3:1 sand/cement mortar to BS 5534
- ▲ complete hip at ridge or top abutment with lead saddle

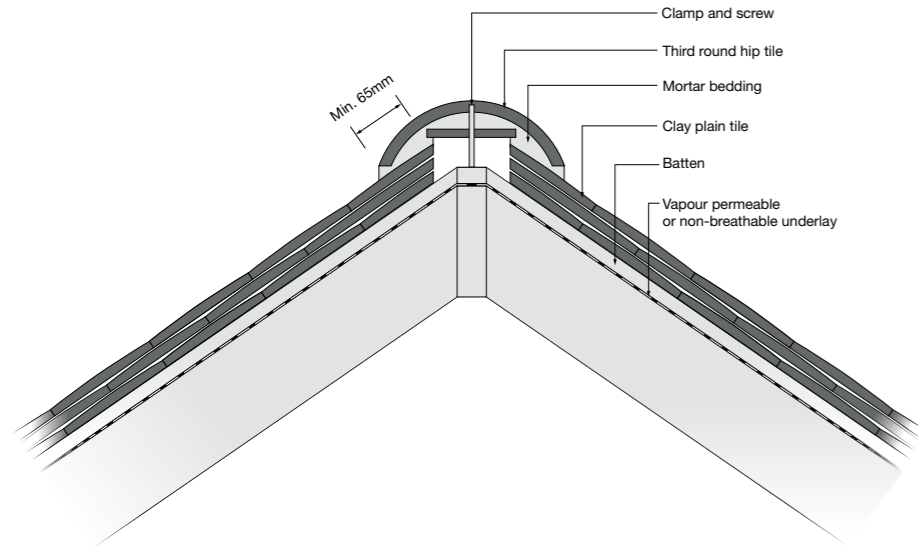
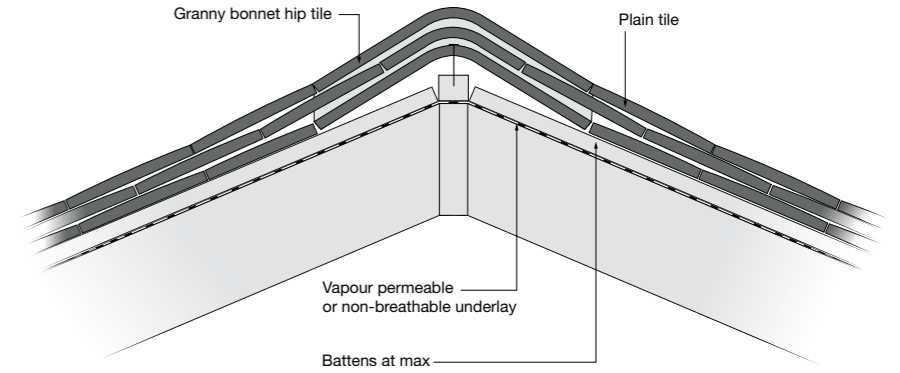

MORTAR BEDDED SECURITY HIP (MECHANICAL FIXING)

- ▲ fix galvanised hip iron at base of hip
- ▲ edge bed hip tiles onto close mitred tiles with 3:1 sand/cement mortar
- ▲ mechanically fix in line with BS 5534. Security ridge packs are available for half round and third round ridges (Code 43605)
- ▲ complete hip at ridge apex with three way mitre or half round ridge hip end

Watch a quick video on mortar bedded mechanical fixing at marley.co.uk/securityhip

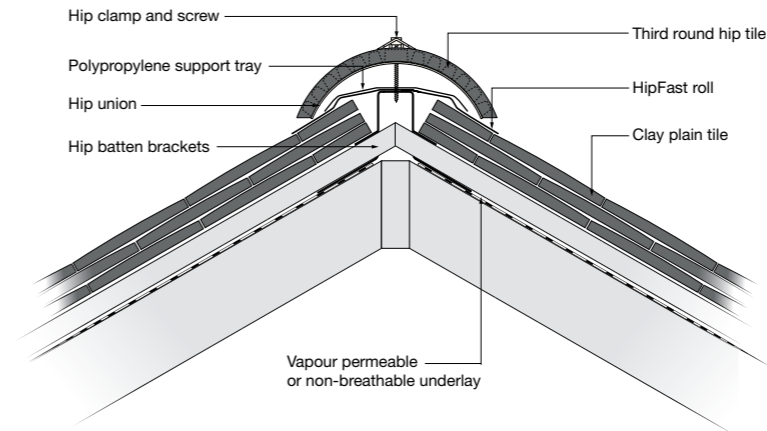

UNIVERSAL HIPFAST DRY HIP SYSTEM

Provides additional ventilation to the roof void when a 5mm gap is provided in the underlay and is used in conjunction with either eaves or ridge ventilation systems, or vent tiles.

- ▲ maximum rafter pitch 60°
- ▲ provides additional ventilation to the roof void when a 5mm gap in the underlay is used in conjunction with either eaves or ridge ventilated systems or ventilation tiles
- ▲ use one or two thicknesses of 50mm x 25mm batten to fit batten brackets
- ▲ use block end hip tile at eaves
- ▲ mechanically fixes each hip tile via hip unions and clamps
- ▲ complete hip at ridge with lead soaker/saddle

TECHNICAL TOOLKIT

Marley provides a comprehensive technical service and a range of online tools to ensure design performance and compliance to the latest Building Regulations and NHBC Technical Standards. These services include:

- ▲ Fixing specifications marley.co.uk/fixingspec
- ▲ NBS clauses marley.co.uk/specrite
- ▲ CAD details marley.co.uk/cad
- ▲ BIM models marley.co.uk/bim

DESIGN DETAILS VALLEYS

GRP DRY VALLEY

- ▲ maximum valley length 8m
- ▲ suitable for all plan angles and where the pitch either side of the valley varies by a maximum of 20°
- ▲ provides continuous support for valley trough using 19mm timber ply boards inset between rafters or 6mm continuous ply boards laid over rafters
- ▲ tightly butt tiles or slates to central upstand of valley units to prevent ingress of birds or vermin
- ▲ provide metal apron at foot of valley and dress into gutter at eaves. For rafter pitches below 25° cut fascia board to maintain valley pitch
- ▲ nail or clip adjacent tiles to the valley and avoid small cuts by using half tiles as penultimate tile to valley. Fix smaller cut tiles with secret cut tile clips
- ▲ complete top of valley with a lead saddle

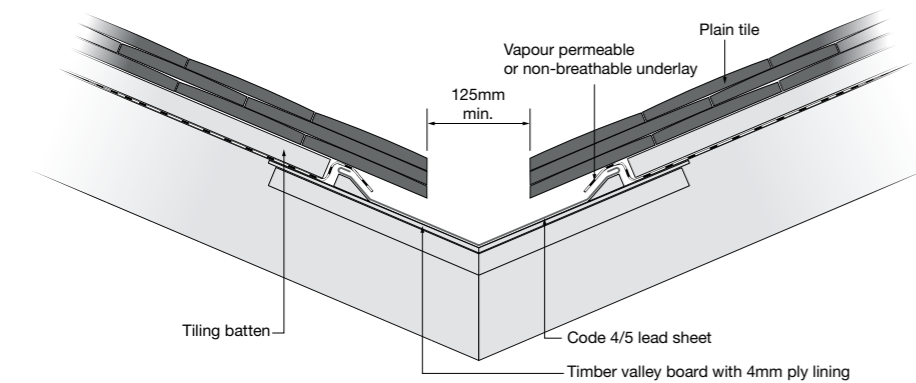

SHEET METAL VALLEY

- ▲ minimum rafter pitch 35°
- ▲ suitable for all plan angles and where the pitch either side of the valley varies
- ▲ provide continuous support for metal valley lining using timber lay boards inset between rafters with 4mm ply lining board over
- ▲ form 125mm minimum gap between raking cut tiles
- ▲ carry metal lining into gutter at eaves
- ▲ use tile-and-a-half tiles to minimise small cut tiles
- ▲ nail all adjacent tiles to the valley
- ▲ complete top of valley with a lead saddle

DESIGN DETAILS VALLEYS & ABUTMENT

PURPOSE MADE VALLEY TILES

- Suitable for all clay plain tiles. Vapour permeable underlay shown.
- ▲ a range of valley tiles are available to suit 30-50° roof pitches
 - ▲ suitable for a plan angle of 90° only and equal pitches either side of the valley
 - ▲ provide continuous support for valley tile using timber lay boards or battens inset between rafters
 - ▲ use tile-and-a-half tiles adjacent to valley tile to avoid small cuts
 - ▲ complete top of valley with a lead saddle

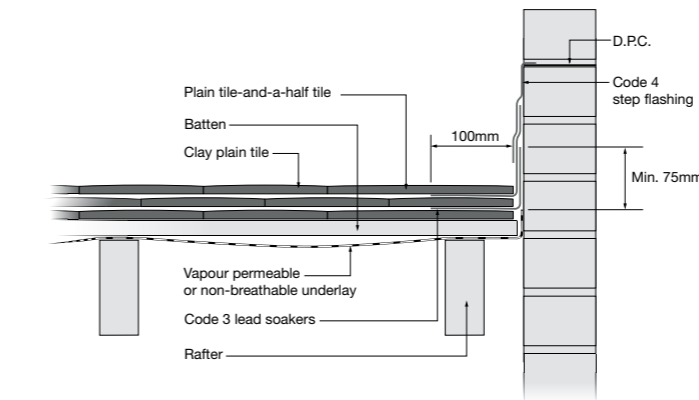

SIDE ABUTMENT

- ▲ bring tiles as close to abutment as possible
- ▲ use Code 3 lead soakers or Marley GRP soakers and Code 4 lead cover flashing

TECHNICAL TOOLKIT

Marley provides a comprehensive technical service and a range of online tools to ensure design performance and compliance to the latest Building Regulations and NHBC Technical Standards. These services include:

- ▲ Fixing specifications marley.co.uk/fixingspec
- ▲ NBS clauses marley.co.uk/specrite
- ▲ CAD details marley.co.uk/cad
- ▲ BIM models marley.co.uk/bim

DESIGN DETAILS RIDGES

UNIVERSAL RIDGEFAST DRY RIDGE SYSTEM

- ▲ maximum rafter pitch 60°
- ▲ provides 5,000mm²/m free vent area at ridge apex
- ▲ ensure gap is provided in roof underlay to vent roof void
- ▲ use one or two thicknesses of 50mm x 25mm batten to fit batten brackets
- ▲ mechanically fix all top course tiles
- ▲ use block end ridge tile at ridge end

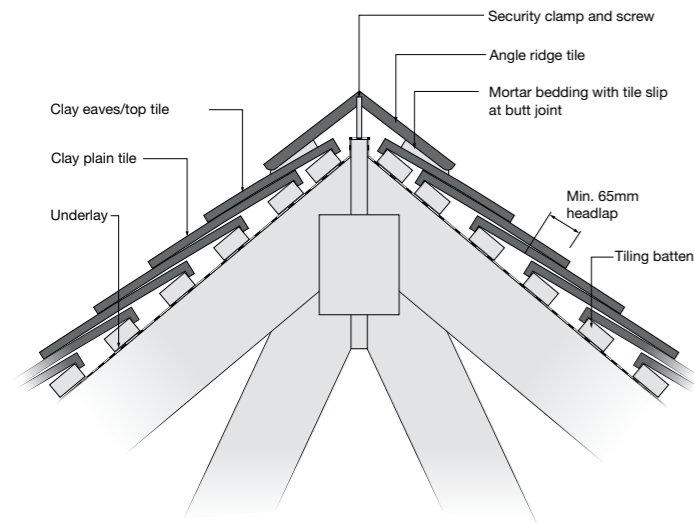
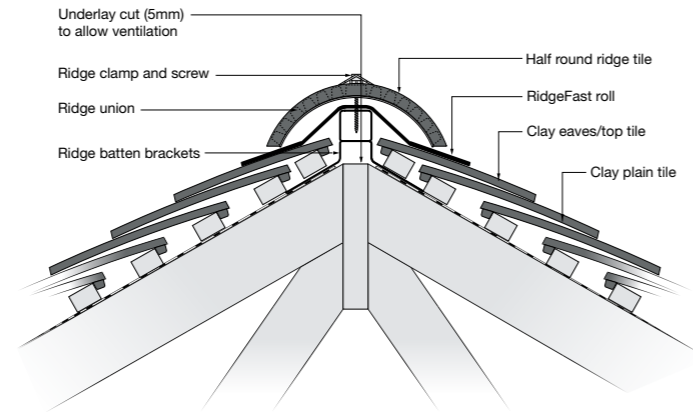

MORTAR BEDDED SECURITY RIDGE (MECHANICAL FIXING)

- ▲ mechanically fix ridge tile in line with BS 5534 fixing guidelines
- ▲ security ridge packs are available for all angle, half round, third round, hog's back and decorative ridge tiles, except Roll Top ridges (Code 43605)

Watch a quick video on mortar bedded mechanical fixing at marley.co.uk/securityridge

TECHNICAL TOOLKIT

Marley provides a comprehensive technical service and a range of online tools to ensure design performance and compliance to the latest Building Regulations and NHBC Technical Standards. These services include:

- ▲ Fixing specifications marley.co.uk/fixingspec
- ▲ NBS clauses marley.co.uk/specrite
- ▲ CAD details marley.co.uk/cad
- ▲ BIM models marley.co.uk/bim

DESIGN DETAILS ROOF SLOPES

UNIVERSAL PLAIN TILE VENT TERMINAL

Vapour permeable underlay shown.

- ▲ locate clear of rafters
- ▲ use soaker tray to weather hole in underlay
- ▲ locate at 2.0m centres for 5,000mm²/lin.m ventilation and 1.0m centres for 10,000mm²/lin.m ventilation
- ▲ suitable for roof space ventilation, mechanical extract and soil vent pipe
- ▲ use flexible pipe for connection to 110mm dia. pipework as termination to mechanical extract or soil vent pipe
- ▲ do not use as exhaust for hot flue gases
- ▲ when used as extract for soil vent pipes, keep minimum 900mm above any opening into building within 3m of vent terminal

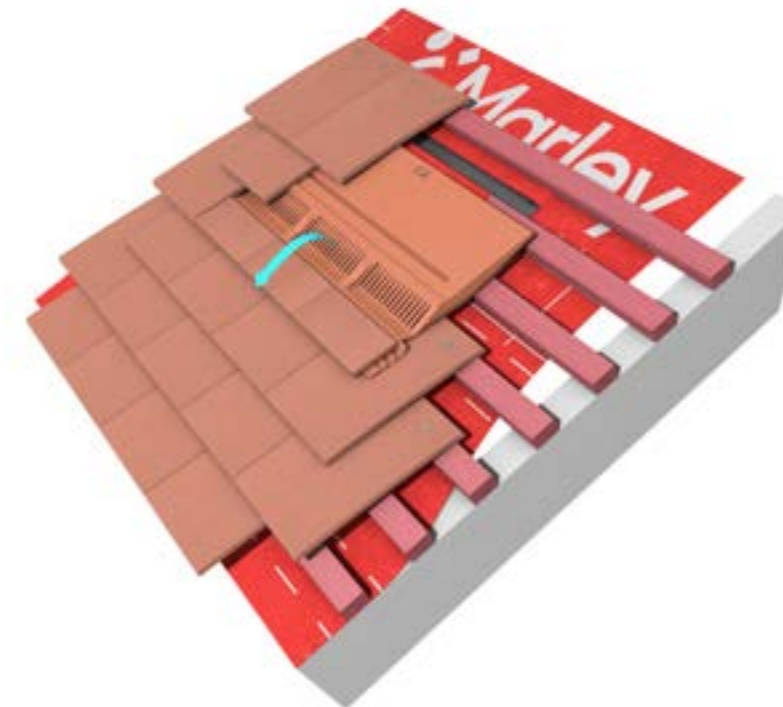
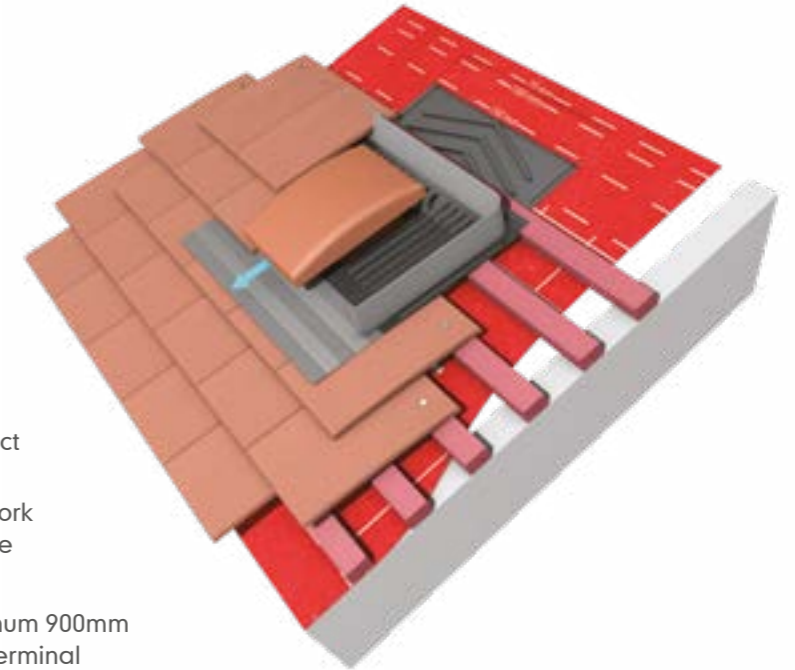

IN-LINE CLAY TILE VENT TERMINAL

Vapour permeable underlay shown.

- ▲ locate clear of rafters
- ▲ use soaker tray to weather hole in underlay for spigot
- ▲ locate at 1.5m centres for 5,000mm²/lin.m ventilation and 0.75m centres for 10,000mm²/lin.m ventilation
- ▲ use tile vent adaptor and flexible pipe for connection to 110mm dia. pipework as termination to mechanical extract or soil vent pipe
- ▲ do not use as exhaust for hot flue gases
- ▲ when used as extract for soil vent pipes, keep minimum 900mm above any opening into building within 3m of vent terminal

DESIGN DETAILS

OTHER CONSTRUCTIONS

CHANGE OF PITCH

- ▲ provide timber layboard and fillet for lead flashing
- ▲ maintain continuous lap of underlay at junction of two pitches
- ▲ extend upper course of tiles over lead to conceal flashing
- ▲ allow minimum 150mm lap of flashing onto lower course of tiles

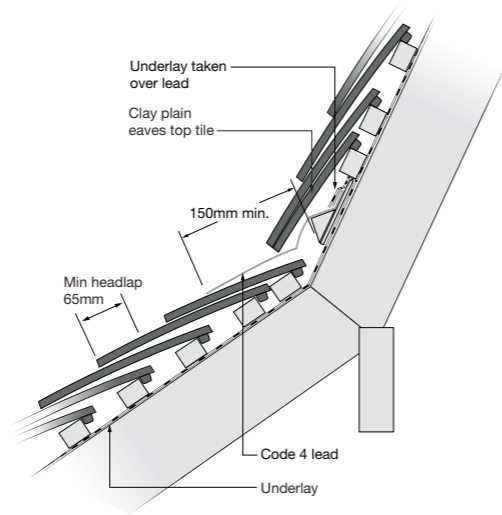

CURVED AND CONICAL ROOFS

Curved roofs can be designed with either horizontal or vertical curves, or a combination of both to form a dome. Double-lap clay plain tiles are the most suitable covering as they are relatively thin and are easily tapered to accommodate the radius of the roof. Designers should, however, be aware of the limitations of using tiles on curved roofs, as the shape and pitch may compromise their function as a weatherproof roof covering. In these circumstances, the tiles are decorative and a suitable weatherproof sub-roof should be provided.

Conical roofs can be formed as a complete circle on plan, as in the case of a turret or can also be segmental as in an apse end.

The following points should be considered when designing a curved or conical roof:

- ▲ maintain a steep roof pitch – 55° and above. (At pitches below this, extensive use of tile-and-a-half tiles may be required to maintain the necessary side laps below).
- ▲ consider the maximum and minimum radii of the curve – this will dictate the available taper in the tile and the side-lap that can be achieved. Plain tiles require a minimum side lap of 55mm (35-55° rafter pitch), and 45mm (56° rafter pitch and over) in moderate exposure.
- ▲ keep spacing of the rafters at 450mm or less.
- ▲ provide two or three layers of plywood (min. thickness 4.5mm) or softwood boards (min. thickness 15mm) with counter layers laid diagonally around radius of the roof as groundwork for battens or for direct nailing of tiles.

EYEBROW DORMERS

This form of curved roof using clay tiles has been derived from thatched roofs, where the thatch was swept over dormer windows providing daylight to the habitable roof void.

When designed for the application of clay tiles, they have the effect of parting the courses horizontally, but the final shape of the eyebrow is dictated by structural considerations and the ability of the design to be weathertight.

The following points should be noted when designing an eyebrow dormer:

- ▲ best formed in roofs of 55° pitch or above
- ▲ pitch of eyebrow should not be less than 35° in moderate exposure
- ▲ the transition curve of the eave should be as smooth as possible with the actual span of the total transition not more than 10 units for each unit of height of the window opening (measured from top tile below to the eaves tile at the centre of the eyebrow)
- ▲ the two central rafters should intersect with the roof slope a minimum of 1m down from the ridge
- ▲ use metal soakers with tiles on the eyebrow where the roof pitch is below 55°
- ▲ the bond of the tiles should be set out from the two sides towards the centre to give an increased side lap on the lower side
- ▲ provide special groundwork for the battens, which should be scarfed to fit the swept profile of the roof timbers
- ▲ allow at least 900mm of regular tiling to follow from the sweep of the eyebrow

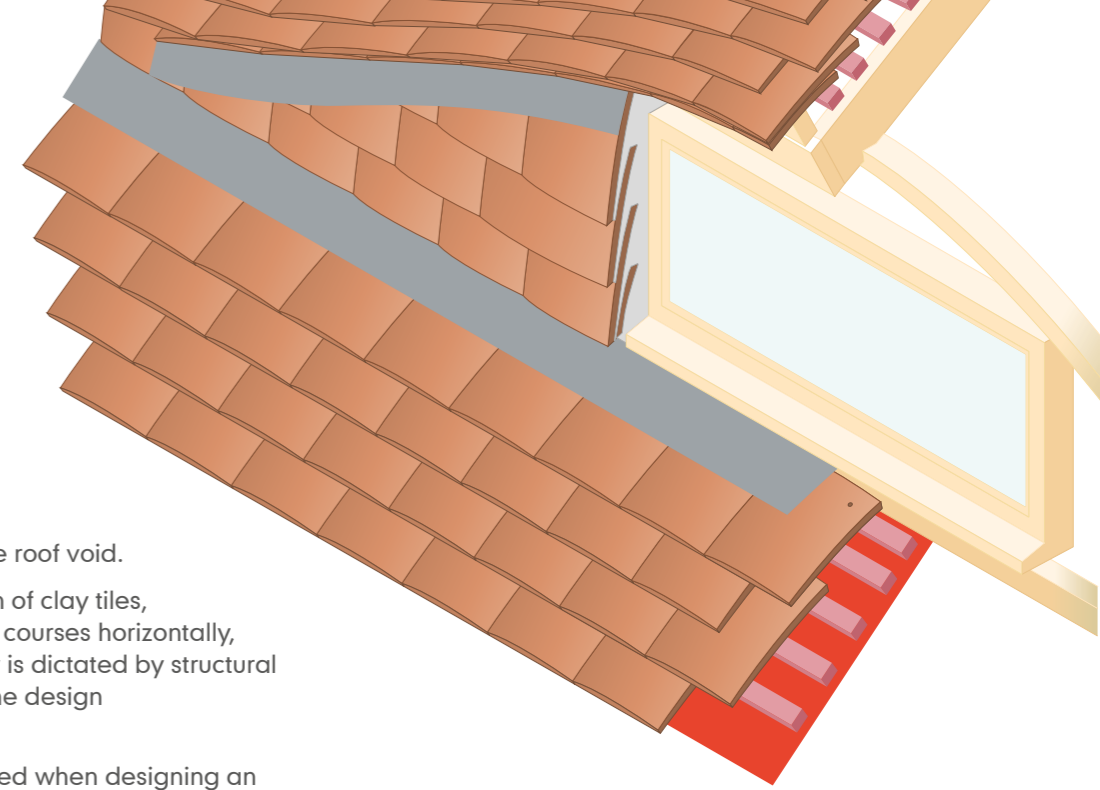

CREASING TILES

Creasing tiles are nibless clay plain tiles and can be used for cappings or copings to walls and sills. Their decorative and crisp lines can also be used in corbelling, arches, chimneys and decorative quoins and their weatherproof properties make them ideal for use in free-standing walls and parapets. Available in Red Smooth.

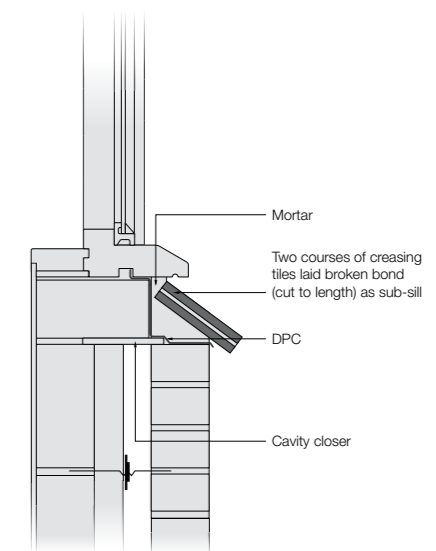

DESIGN DETAILS

OTHER CONSTRUCTIONS

VERTICAL TILING

Clay plain tiling is an excellent weatherproof and attractive cladding to the vertical walls of any building. Feature and ornamental tiles may also be used with clay plain tiles to create decorative patterns.

- ▲ use counter battens over masonry construction (38mm x 25mm minimum) to reduce direct fixing. Special masonry fixings may be required
- ▲ ensure tiling details do not interfere with the opening of windows and doors
- ▲ lead flashings and soakers should be used around openings in accordance with Lead Sheet Association details
- ▲ use double course of tiles at eaves, by laying first course of eaves/tops tiles with course of full tiles over
- ▲ at top of wall or under a sill, use a course of eaves/tops tile laid over a course of full tiles. Dress a Code 4 lead cover flashing over by 100mm
- ▲ use internal and external angle tiles at all 90° corners. Purpose made 135° angle tiles are also available. For other angles, close mitre tiles and use Code 3 lead soakers
- ▲ all tiles should be twice nailed

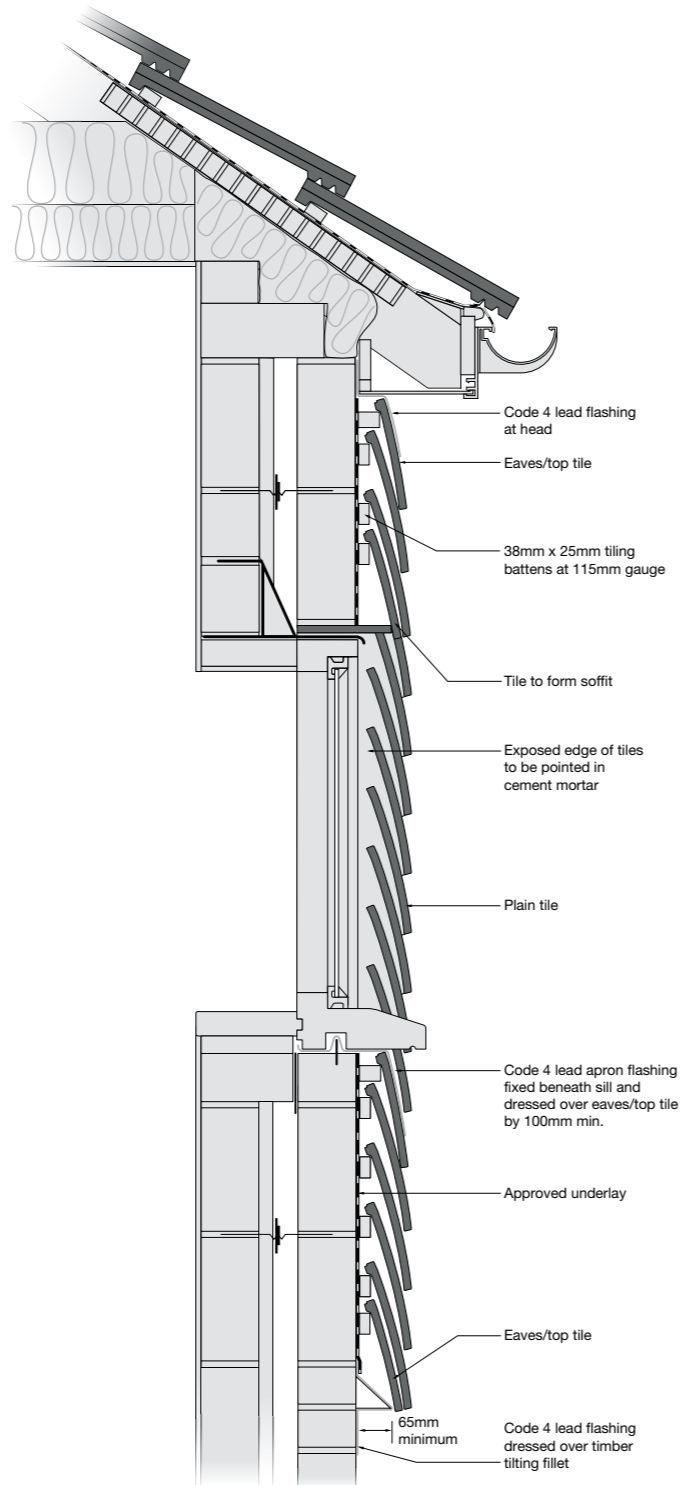

90° EXTERNAL ANGLE TILES

Vertical angle tiles are available in left and right handed formats to fit 90° and 135° angle external corners of wall elements and are designed to bond with standard plain tiles. The following guidance notes apply to this detail:

- ▲ counter battens, where used, should be fixed 20mm in from the end of the tiling battens at the corner, to prevent the end nail or screw fixing from splitting the tile batten
- ▲ cut ends of the tiling battens should be alternated to coincide with the short leg of the external angle tiles
- ▲ fix left and right handed external angle tiles in alternate courses up the external corner to fit with the adjacent standard plain tiles
- ▲ avoid cutting the angle tiles to fit with the adjacent tiles
- ▲ secure each vertical angle tile by twice nailing

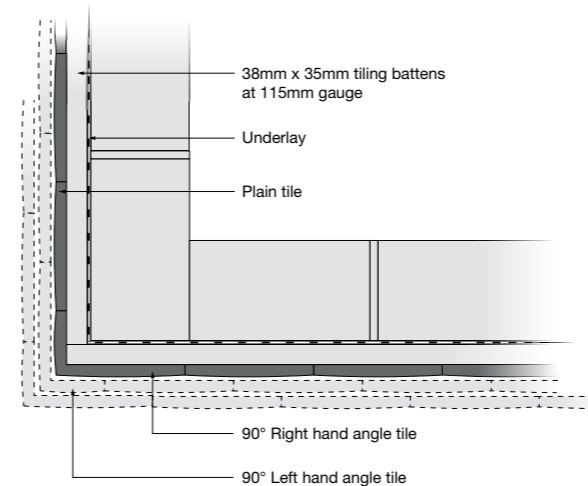

WINCHESTER CUT

This gable end detail avoids the use of small triangular pieces of tile by providing a secure fixing of a tile-and-a-half against the rake of the gable.

- ▲ best suited for roof pitches of 40° and above
- ▲ fix batten parallel with rake of verge and level with vertical tiling battens
- ▲ use tile-and-a-half at end of each course and cut to rake (all tiles should be of uniform cut)
- ▲ cut adjacent tile to raking cut tile-and-a-half
- ▲ use Code 3 lead soakers (200mm x 200mm) where side laps are less than 55mm
- ▲ at apex use a tile-and-a-half turned through 45° and cut to shape

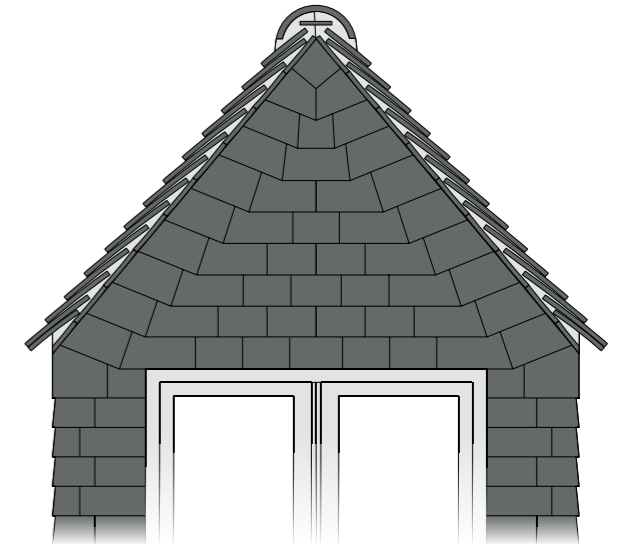

TECHNICAL TOOLKIT

Marley provides a comprehensive technical service and a range of online tools to ensure design performance and compliance to the latest Building Regulations and NHBC Technical Standards. These services include:

- ▲ Fixing specifications marley.co.uk/fixingspec
- ▲ NBS clauses marley.co.uk/specrite
- ▲ CAD details marley.co.uk/cad
- ▲ BIM models marley.co.uk/bim



Here to help

Getting our knowledge to you and your project smoothly and efficiently

▲ CUSTOMER SERVICES

Marley is committed to providing outstanding customer care and is staffed by experienced personnel: [Tel 01283 722588](tel:01283722588) or e-mail info@marley.co.uk

To find your nearest stockist, please visit: marley.co.uk/stockists

▲ TECHNICAL ADVISORY SERVICE

Specifiers require prompt, knowledgeable and detailed responses to a vast range of enquiries covering everything from the embodied energy of a typical roof tile, to the different ventilation options available.

Our Technical Advisory Service is staffed by an experienced team with specialist knowledge not only of all Marley products, but also crucially, how those systems integrate with other roofing components and comply with Building Regulations, Health and Safety, environmental and other critical roofing criteria.

[Tel 01283 722330](tel:01283722330) or E-mail roofing@marley.co.uk

▲ ACTING RESPONSIBLY AND DELIVERING SUSTAINABLE QUALITY

BES 6001

Demonstrating our commitment to sustainable building, all our roofing products are certified under the BES 6001 standard for responsible sourcing and therefore contribute to extra credits under BREEAM and The Code for Sustainable Homes.

QUALITY STANDARD

All our factories in the UK are ISO 9001, 14001 and ISO OHSAS 18001 accredited. They achieve the highest standards in quality, health & safety and the environment.

CE MARKING

All of our products covered by EN Standard carry an appropriate CE Mark. This means that our products meet the required safety standards and have a guaranteed level of quality.

▲ TOOLS

Tools and assets that make design and specification as straightforward as possible.

SPECRITE

Produce instant NBS clauses that meet the recommendations of British Standards and Codes of Practice: marley.co.uk/specrite

FIXINGSPEC

Tool to create fixing specifications based on the geographical location and building dimensions of specific roofing projects: marley.co.uk/fixingspec

ROOFING ESTIMATOR

Create a complete bill of materials for your project based on a wide range of building and roof types: marley.co.uk/estimator

BIM

BIM Space is a set of free-to-download Building Information Modelling (BIM) objects that provide a standard range of build ups for all of our products: marley.co.uk/bim

CAD DETAILS

Access to over 2,000 CAD drawings illustrating how specific tile and slate details can be formed: marley.co.uk/cad

▲ RESOURCES AND TRAINING

SAMPLES

Samples of clay and concrete interlocking and plain tiles are available on request.

Call [01283 722588](tel:01283722588) or visit marley.co.uk/samples

FIXING INSTRUCTIONS AND LITERATURE

Comprehensive sitework, fixing and installation literature and videos: marley.co.uk/resources

All current product and technical literature can be downloaded: marley.co.uk/downloads

CPDs

A range of Continuous Professional Development roofing seminars accredited by the RIBA CPD Certification Service. For more information or to make a booking: marley.co.uk/cpd

TRAINING

Theoretical, practical, engaging and informative training available at three locations nationwide.

marley.co.uk/training

This publication is based on the latest data available at the time of printing. Due to product changes, improvements and other factors, the Company reserves the right to change or withdraw information contained herein without prior notice. For specific applications users should refer to the Technical Advisory Service and relevant Standards and Codes of Practice for guidance. The photography shown in the document should not necessarily be taken as recommendations of good practice. The printing process restricts the exact representation of colours. For true colour reference, please request product samples.

Changes from V1.0: Removal of Ashdowne tiles and Acme Double Camber tiles. Addition of Autumn Brindle to Acme Single Camber Standard range. Addition of Ashurst, Aylesham Mix and Weathered to Acme Single Camber Heritage range.



Tell me more

Call 01283 722588

Email info@marley.co.uk

Or visit marley.co.uk

Marley, Lichfield Road, Branston, Burton upon Trent, DE14 3HD

